

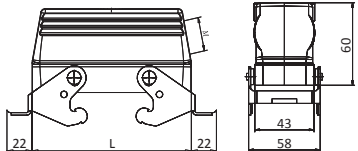









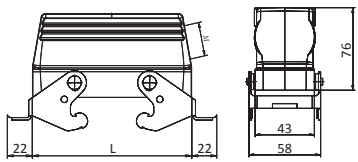

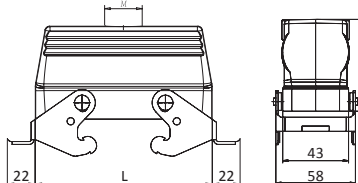
H8A 防护外壳 HOODS / HOUSINGS

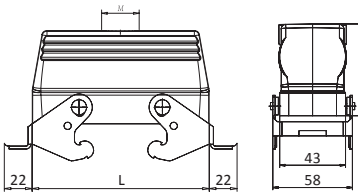
塑料外壳 Plastic hoods/housings	型号 Type	订货号 Part No.	M 制 Metr.	比例图 Drawing	尺寸: 单位 Dimensions in mm
上壳 侧面进线 Side entry 	H8A-TS-M25	2120080501	25		54
上壳 顶部进线 Top entry 	H8A-TG-M25	2120080429	25		
下壳 开孔安装 Housings, bulkhead mounting 	H8A-AG	2120080327			28.7
下壳 开孔安装 Housings, bulkhead mounting 	H8A-AGM	2120080301			
旋紧件 Tighten the pieces 	SVL-25	2120005157	25		

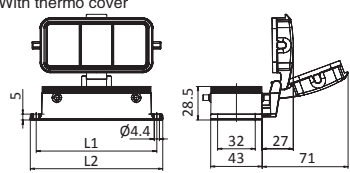
特殊外壳系列 SPECIAL HOODS SERIES

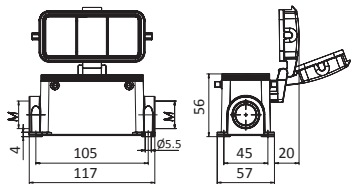
名称 Identification	型号 Type	订货号 Part No.	Metr.	比例图 Drawing	尺寸: 单位 Dimensions in mm												
上壳 侧出带双扣 Side entry hoods with two levers 	H10B-TSB-M20	2300101530	20		<table border="1"> <thead> <tr> <th>SIZE</th> <th>L(mm)</th> </tr> </thead> <tbody> <tr> <td>H10B</td> <td>82</td> </tr> <tr> <td>H16B</td> <td>93.5</td> </tr> <tr> <td>H24B</td> <td>120</td> </tr> </tbody> </table>	SIZE	L(mm)	H10B	82	H16B	93.5	H24B	120				
	SIZE	L(mm)															
	H10B	82															
	H16B	93.5															
	H24B	120															
	H10B-TSB-M25	2300101531	25														
H16B-TSB-M25	2300161531	25															
H16B-TSB-M32	2300161532	32															
H24B-TSB-M25	2300241531	25															
H24B-TSB-M32	2300241532	32															
上壳 侧出带双扣 高结构 Side entry hoods with two levers 	H10B-TSBH-M25	2300100536	25		<table border="1"> <thead> <tr> <th>SIZE</th> <th>L(mm)</th> </tr> </thead> <tbody> <tr> <td>H10B</td> <td>82</td> </tr> <tr> <td>H16B</td> <td>93.5</td> </tr> <tr> <td>H24B</td> <td>120</td> </tr> </tbody> </table>	SIZE	L(mm)	H10B	82	H16B	93.5	H24B	120				
	SIZE	L(mm)															
	H10B	82															
	H16B	93.5															
	H24B	120															
	H10B-TSBH-M32	2300100537	32														
	H10B-TSBH-M40	2300100538	40														
	H16B-TSBH-M25	2300160536	25														
H16B-TSBH-M32	2300160537	32															
H16B-TSBH-M40	2300160538	40															
H24B-TSBH-M25	2300240536	25															
H24B-TSBH-M32	2300240537	32															
H24B-TSBH-M40	2300240538	40															
上壳 顶出带双扣 Top entry hoods with two levers 	H10B-TGB-M20	2300101430	20		<table border="1"> <thead> <tr> <th>SIZE</th> <th>L(mm)</th> </tr> </thead> <tbody> <tr> <td>H10B</td> <td>82</td> </tr> <tr> <td>H16B</td> <td>93.5</td> </tr> <tr> <td>H24B</td> <td>120</td> </tr> </tbody> </table>	SIZE	L(mm)	H10B	82	H16B	93.5	H24B	120				
	SIZE	L(mm)															
	H10B	82															
	H16B	93.5															
	H24B	120															
	H10B-TGB-M25	2300101431	25														
H16B-TGB-M25	2300161431	25															
H16B-TGB-M32	2300161432	32															
H24B-TGB-M25	2300241431	25															
H24B-TGB-M32	2300241432	32															
上壳 顶出带双扣 高结构 Top entry hoods with two levers 	H10B-TGBH-M25	2300100436	25		<table border="1"> <thead> <tr> <th>SIZE</th> <th>L(mm)</th> </tr> </thead> <tbody> <tr> <td>H10B</td> <td>82</td> </tr> <tr> <td>H16B</td> <td>93.5</td> </tr> <tr> <td>H24B</td> <td>120</td> </tr> </tbody> </table>	SIZE	L(mm)	H10B	82	H16B	93.5	H24B	120				
	SIZE	L(mm)															
	H10B	82															
	H16B	93.5															
	H24B	120															
	H10B-TGBH-M32	2300100437	32														
	H10B-TGBH-M40	2300100438	40														
	H16B-TGBH-M25	2300160436	25														
H16B-TGBH-M32	2300160437	32															
H16B-TGBH-M40	2300160438	40															
H24B-TGBH-M25	2300240436	25															
H24B-TGBH-M32	2300240437	32															
H24B-TGBH-M40	2300240438	40															
下壳 四耳带盖开孔底座 Bulkhead mounting with 4 bolts 	H10B-AD-BO	2300100302		带保护盖 With thermo cover 	<table border="1"> <thead> <tr> <th>SIZE</th> <th>L1 (mm)</th> <th>L2 (mm)</th> </tr> </thead> <tbody> <tr> <td>H10B</td> <td>83</td> <td>93</td> </tr> <tr> <td>H16B</td> <td>103</td> <td>113</td> </tr> <tr> <td>H24B</td> <td>130</td> <td>140</td> </tr> </tbody> </table>	SIZE	L1 (mm)	L2 (mm)	H10B	83	93	H16B	103	113	H24B	130	140
	SIZE	L1 (mm)	L2 (mm)														
	H10B	83	93														
H16B	103	113															
H24B	130	140															
H16B-AD-BO	2300160302																
H24B-AD-BO	2300240302																
若只需一个电缆输出端时, 需另外订购封口螺栓 Blind way one cable entry, order blind separately																	
下壳 四耳带盖表面安装底座 Surface mounting with 4 bolts 	H10B-SDR-BO-M20	2300101225	1×20	带保护盖 With thermo cover 	<table border="1"> <thead> <tr> <th>SIZE</th> <th>L1 (mm)</th> <th>L2 (mm)</th> </tr> </thead> <tbody> <tr> <td>H10B</td> <td>82</td> <td>94</td> </tr> <tr> <td>H16B</td> <td>105</td> <td>117</td> </tr> <tr> <td>H24B</td> <td>132</td> <td>144</td> </tr> </tbody> </table>	SIZE	L1 (mm)	L2 (mm)	H10B	82	94	H16B	105	117	H24B	132	144
	SIZE	L1 (mm)	L2 (mm)														
	H10B	82	94														
	H16B	105	117														
	H24B	132	144														
	H10B-SDR-BO-M25	2300101226	1×25														
	H10B-SDR-BO-2M20	2300101265	2×20														
	H10B-SDR-BO-2M25	2300101266	2×25														
H16B-SDR-BO-M25	2300161226	1×25															
H16B-SDR-BO-2M25	2300162226	2×25															
H24B-SDR-BO-M25	2300241226	1×25															
H24B-SDR-BO-2M25	2300241266	2×25															
若只需一个电缆输出端时, 需另外订购封口螺栓 Blind way one cable entry, order blind separately																	
下壳 四耳带盖表面安装底座 高结构 Surface mounting with 4 bolts 	H10B-SDRH-BO-M32	2300100227	1×32	带保护盖 With thermo cover 	<table border="1"> <thead> <tr> <th>SIZE</th> <th>L1 (mm)</th> <th>L2 (mm)</th> </tr> </thead> <tbody> <tr> <td>H10B</td> <td>82</td> <td>94</td> </tr> <tr> <td>H16B</td> <td>105</td> <td>117</td> </tr> <tr> <td>H24B</td> <td>132</td> <td>144</td> </tr> </tbody> </table>	SIZE	L1 (mm)	L2 (mm)	H10B	82	94	H16B	105	117	H24B	132	144
	SIZE	L1 (mm)	L2 (mm)														
	H10B	82	94														
	H16B	105	117														
	H24B	132	144														
	H10B-SDRH-BO-2M32	2300100267	2×32														
H16B-SDRH-BO-M32	2300161225	1×32															
H16B-SDRH-BO-2M25	2300162225	2×25															
H24B-SDRH-BO-M32	2300240267	1×32															
H24B-SDRH-BO-2M32	2300242267	2×32															
若只需一个电缆输出端时, 需另外订购封口螺栓 Blind way one cable entry, order blind separately																	

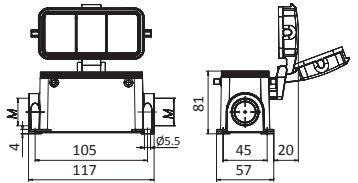

备注 Notes: 开孔尺寸图请参照 7.12.2 页

特殊外壳系列 SPECIAL HOODS SERIES

(IP65) 用于特殊用途 (开孔位置和数量可选)

名称 Identification	规格 Size	型号 Type	订货号 Part No.	Metr.	比例图 Drawing	尺寸: 单位 Dimensions in mm
上壳 顶部进线 Hoods top entry  	H10B	H10B-TGH-2M20	2300100465	2×20		
	H16B H16B	H16B-TGH-2M25 H16B-TGH-M20/32	2300160466 2300160566	2×25 20+32		
	H24B H24B H24B	H24B-TGH-2M25 H24B-TGH-2M32 H24B-TGH-M25/32	2300240466 2300240467 2300240567	2×25 2×32 25+32		
	H32B	H32B-TGH-2M32	2300320467	2×32		

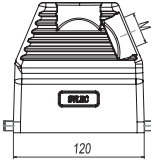
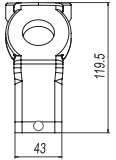
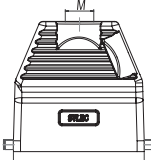
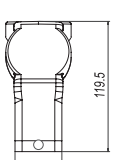

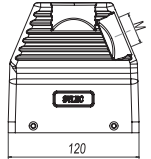
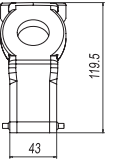
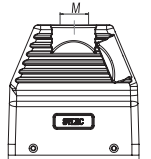
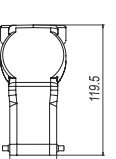
用于特殊用途 (开孔位置和数量可选)

名称 Identification	规格 Size	型号 Type	订货号 Part No.	Metr.	比例图 Drawing	尺寸: 单位 Dimensions in mm
上壳单扣 Hoods 	H24B	H24B-TSH-RO-M50	2300240568	1×50		
	H24B	H24B-TGH-RO-M50	2300240569	1×50		
上壳双扣 Hoods 	H24B	H24B-TSH-M50	2300240558	1×50		
	H24B	H24B-TGH-M50	2300240559	1×50		

HB 中部锁定金属外壳 CENTRAL LOCKING METAL CASE



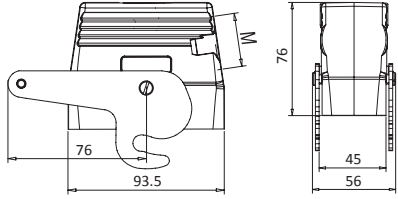
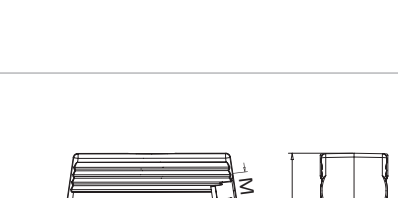
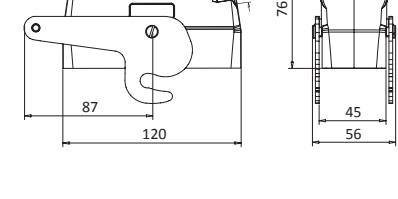
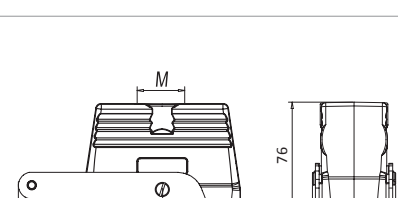

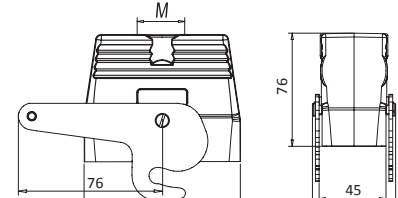
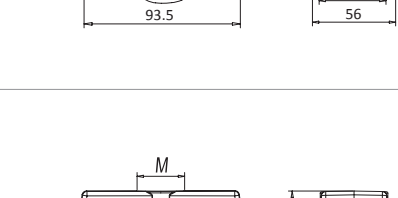
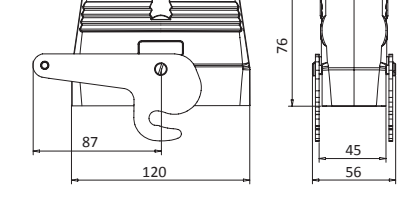
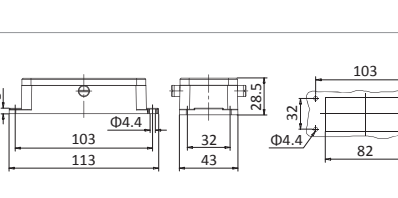
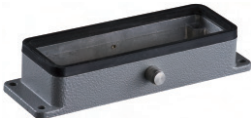
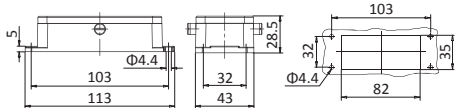
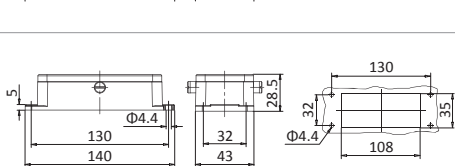



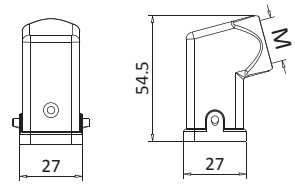

HB 中部锁定 (IP65) 系列

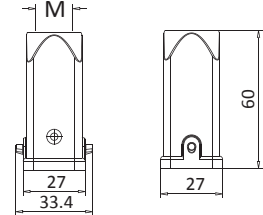
名称 Identification	规格 Size	型号 Type	订货号 Part No.	Metr.	
上壳 侧面进线 Hoods side entry 	H16B	H16B-TSH-RC-M25	2370160586	25	
	H16B	H16B-TSH-RC-M32	2370160587	32	
	H24B	H24B-TSH-RC-M32	2370240587	32	
	H24B	H24B-TSH-RC-M40	2370240588	40	
上壳 顶部出线 Hoods top entry 	H16B	H16B-TGH-RC-M32	2370160487	32	
	H16B	H16B-TGH-RC-M40	2370160488	40	
	H24B	H24B-TGH-RC-M32	2370240487	32	
	H24B	H24B-TGH-RC-M40	2370240488	40	
下壳 开孔安装 Housings, bulkhead mounting 	H16B	H16B-AG-RC	2300160381		
	H24B	H24B-AG-RC	2300240381		

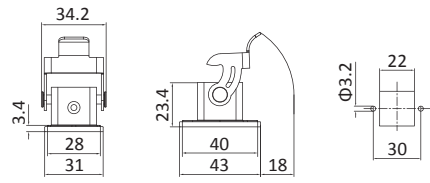
IP65 防护外壳

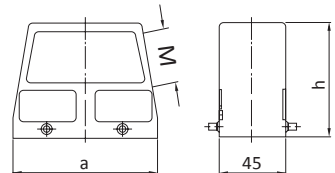
EMC 防护外壳 HOODS/HOUSINGS

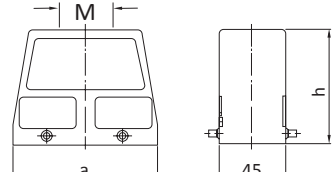
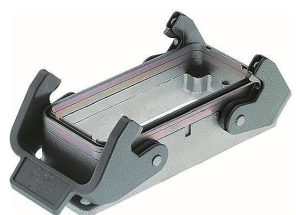
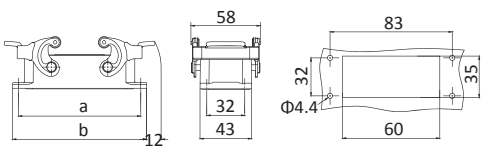



名称 Identification	规格 Size	型号 Type	订货号 Part No.	Metr.	比例图 Drawing	尺寸: 单位 Dimensions in mm																				
上壳 侧部进线 Hoods side entry 	H3A	H3AEMCS-TS-M20	2620031640	20																						
上壳 顶部进线 Hoods top entry 	H3A	H3AEMCS-TG-M20	2620031440	20																						
下壳 开孔安装 Housings, bulkhead mounting 	H3A	H3AEMCS-AG	2620030301																							
上壳 侧部进线 Hoods side entry 	6B	H6BEMCS-TSH-M25	2628161521	25	 <table border="1" data-bbox="1005 1239 1412 1325"> <thead> <tr> <th>制造规格 Size</th> <th>a</th> <th>低结构 Low (h)</th> <th>高结构 High (h)</th> </tr> </thead> <tbody> <tr> <td>6B</td> <td>60</td> <td>43</td> <td>72</td> </tr> <tr> <td>10B</td> <td>73</td> <td>57</td> <td>72</td> </tr> <tr> <td>16B</td> <td>93.5</td> <td>62.5</td> <td>76</td> </tr> <tr> <td>24B</td> <td>120</td> <td>62.5</td> <td>76</td> </tr> </tbody> </table>	制造规格 Size	a	低结构 Low (h)	高结构 High (h)	6B	60	43	72	10B	73	57	72	16B	93.5	62.5	76	24B	120	62.5	76	
制造规格 Size	a	低结构 Low (h)	高结构 High (h)																							
6B	60	43	72																							
10B	73	57	72																							
16B	93.5	62.5	76																							
24B	120	62.5	76																							
	10B	H10BEMCS-TSH-M32	2628160527	32																						
	16B	H16BEMCS-TSH-M32	2628161521	32																						
	24B	H24BEMCS-TSH-M32	2628240528	32																						
顶部进线 Top entry 	6B	H6BEMCS-TGH-M20	2628061440	20	 <table border="1" data-bbox="1005 1563 1412 1649"> <thead> <tr> <th>制造规格 Size</th> <th>a</th> <th>低结构 Low (h)</th> <th>高结构 High (h)</th> </tr> </thead> <tbody> <tr> <td>6B</td> <td>60</td> <td>40</td> <td>72</td> </tr> <tr> <td>10B</td> <td>73</td> <td>45</td> <td>72</td> </tr> <tr> <td>16B</td> <td>93.5</td> <td>55</td> <td>76</td> </tr> <tr> <td>24B</td> <td>120</td> <td>55</td> <td>76</td> </tr> </tbody> </table>	制造规格 Size	a	低结构 Low (h)	高结构 High (h)	6B	60	40	72	10B	73	45	72	16B	93.5	55	76	24B	120	55	76	
制造规格 Size	a	低结构 Low (h)	高结构 High (h)																							
6B	60	40	72																							
10B	73	45	72																							
16B	93.5	55	76																							
24B	120	55	76																							
	10B	H10BEMCS-TGH-M25	2628101420	25																						
	16B	H16BEMCS-TGH-M32	2628161421	32																						
	24B	H24BEMCS-TGH-M32	2628241422	32																						
下壳 开孔安装 Housings, bulkhead mounting 	H6B	H6BEMCS-AG	2628060301		 <table border="1" data-bbox="1005 1864 1412 1972"> <thead> <tr> <th>制造规格 Size</th> <th>a</th> <th>b</th> <th>板材开孔 Panel cut out</th> </tr> </thead> <tbody> <tr> <td>6B</td> <td>70</td> <td>80</td> <td>48×35</td> </tr> <tr> <td>10B</td> <td>83</td> <td>93</td> <td>60×35</td> </tr> <tr> <td>16B</td> <td>103</td> <td>113</td> <td>82×35</td> </tr> <tr> <td>24B</td> <td>130</td> <td>140</td> <td>108×35</td> </tr> </tbody> </table>	制造规格 Size	a	b	板材开孔 Panel cut out	6B	70	80	48×35	10B	83	93	60×35	16B	103	113	82×35	24B	130	140	108×35	
制造规格 Size	a	b	板材开孔 Panel cut out																							
6B	70	80	48×35																							
10B	83	93	60×35																							
16B	103	113	82×35																							
24B	130	140	108×35																							
	H10B	H10BEMCS-AG	2628100301																							
	H16B	H16BEMCS-AG	2628160301																							
	H24B	H24BEMCS-AG	2628240301																							

EMC 特殊外壳

HPR(IP68) 系列金属外壳 METAL HOODS/HOUSINGS SERIES

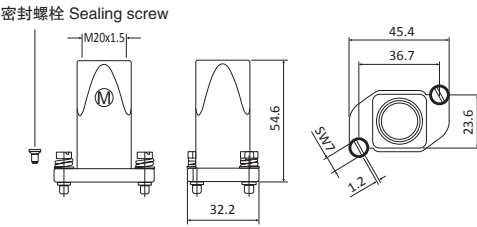

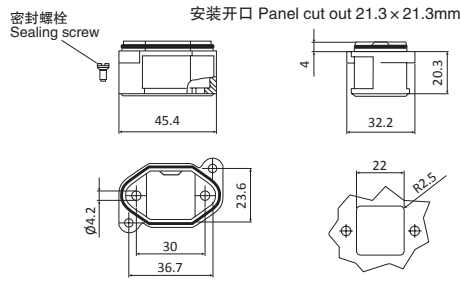
H3APR(IP68) 系列 Series

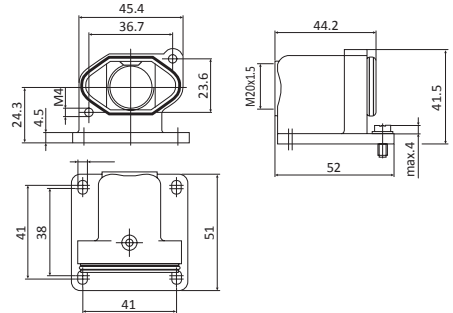
名称 Identification	型号 Type	订货号 Part No.	Metr.	比例图 Drawing	尺寸: 单位 Dimensions in mm
顶部进线 Hoods top entry 	H3APR-MTG-M20	2400030410	20	密封螺栓 Sealing screw 	
底部进线 Housings, bulkhead mounting: bottom entry 	H3APR-MAG	2400030311		密封螺栓 Sealing screw 安装开口 Panel cut out 21.3 x 21.3mm 	
表面进线 Housings, surface mounting: bottom entry 	H3APR-MAGSVB-M20	2400030950	20		

HBPR 对角锁定 (IP68) 系列

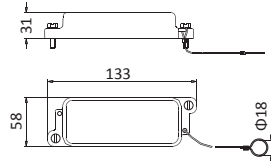
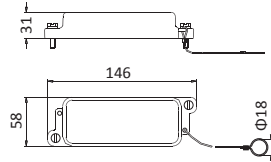
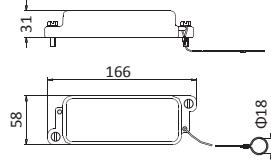
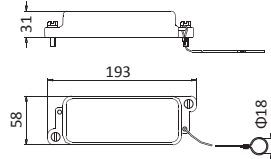
名称 Identification	规格 Size	型号 Type	订货号 Part No.	Metr.	比例图 Drawing	尺寸: 单位 Dimensions in mm
保护盖 Protection covers 	H6BPR	H6BPR-KDB	2400065411			
	H10BPR	H10BPR-KDB	2400105411			
	H16BPR	H16BPR-KDB	2400165411			
	H24BPR	H24BPR-KDB	2400245411			

HPR(IP68) 系列金属外壳 METAL HOODS / HOUSINGS SERIES

HBPR 对角锁定 (IP68) 系列

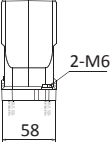
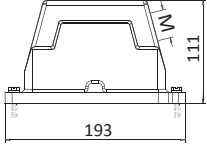
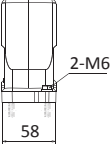
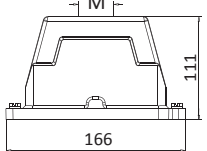
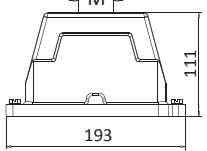
名称 Identification	规格 Size	型号 Type	订货号 Part No.	Metr.	比例图 Drawing	尺寸: 单位 Dimensions in mm
上壳 侧面进线 Hoods side entry 	H6BPR	H6BPR-TSH-M20	2400060510	20		
	H6BPR	H6BPR-TSH-M25	2400060511	25		
	H6BPR	H6BPR-TSH-M32	2400060512	32		
	H6BPR	H6BPR-TSH-M40	2400060513	40		
	H10BPR	H10BPR-TSH-M25	2400100511	25		
	H10BPR	H10BPR-TSH-M32	2400100512	32		
	H10BPR	H10BPR-TSH-M40	2400100513	40		
	H16BPR	H16BPR-TSH-M25	2400160511	25		
	H16BPR	H16BPR-TSH-M32	2400160512	32		
	H16BPR	H16BPR-TSH-M40	2400160513	40		
	H16BPR	H16BPR-TSH-M50	2400160514	50		
	H24BPR	H24BPR-TSH-M25	2400240511	25		
	H24BPR	H24BPR-TSH-M32	2400240512	32		
	H24BPR	H24BPR-TSH-M40	2400240513	40		
	H24BPR	H24BPR-TSH-M50	2400240514	50		
	上壳 顶部进线 Hoods top entry 	H6BPR	H6BPR-TGH-M20	2400060410	1×20	
H6BPR		H6BPR-TGH-M25	2400060411	1×25		
H6BPR		H6BPR-TGH-M32	2400060412	1×32		
H6BPR		H6BPR-TGH-M40	2400060413	1×40		
H10BPR		H10BPR-TGH-M25	2400100411	1×25		
H10BPR		H10BPR-TGH-M32	2400100412	1×32		
H10BPR		H10BPR-TGH-2M20	2400100430	2×20		
H16BPR		H16BPR-TGH-M25	2400160411	1×25		
H16BPR		H16BPR-TGH-M32	2400160412	1×32		
H16BPR		H16BPR-TGH-M40	2400160413	1×40		
H16BPR		H16BPR-TGH-M50	2400160414	1×50		
H24BPR		H24BPR-TGH-M32	2400240412	1×32		
H24BPR		H24BPR-TGH-M40	2400240413	1×40		
H24BPR		H24BPR-TGH-M50	2400240414	1×50		
H24BPR		H24BPR-TGH-2M32	2400240432	2×32		
H24BPR		H24BPR-TGH-2M40	2400240433	2×40		
H24BPR	H24BPR-TGH-2M25	2400240461	3×25			

HPR(IP68) 系列金属外壳 METAL HOODS / HOUSINGS SERIES







HBPR 对角锁定 (IP68) 系列

名称 Identification	规格 Size	型号 Type	订货号 Part No.	Metr.	比例图 Drawing	尺寸: 单位 Dimensions in mm
下壳 开孔安装 Housings, bulkhead mounting	H6BPR	H6BPR-AG	2400060311			
	H10BPR	H10BPR-AG	2400100311			
	H16BPR	H16BPR-AG	2400160311			
	H24BPR	H24BPR-AG	2400240311			
	下壳 表面安装 Surface mounting: Side entry	H6BPR	H6BPR-SGRH-M20	2400061260	1×20	
H6BPR		H6BPR-SGRH-M25	2400061261	1×25		
H6BPR		H6BPR-SGRH-M32	2400061262	1×32		
H10BPR		H10BPR-SGRH-M20	2400101260	1×20		
H10BPR		H10BPR-SGRH-M32	2400101262	1×32		
H10BPR		H10BPR-SGRH-M40	2400101263	1×40		
H10BPR		H10BPR-SGRH-2M25	2400101271	2×25		
H10BPR		H10BPR-SGRH-2M32	2400101272	2×32		
H16BPR		H16BPR-SGRH-M25	2400161261	1×25		
H16BPR		H16BPR-SGRH-M32	2400161262	1×32		
H16BPR		H16BPR-SGRH-M40	2400161263	1×40		
H16BPR		H16BPR-SGRH-2M40	2400161273	2×40		
H24BPR		H24BPR-SGRH-M32	2400241262	1×32		
H24BPR		H24BPR-SGRH-M40	2400241263	1×40		
H24BPR		H24BPR-SGRH-2M40	2400241273	2×40		

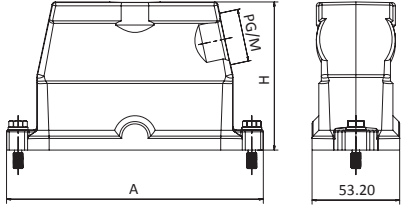
HPR(IP68) 系列金属外壳 METAL HOODS / HOUSINGS SERIES

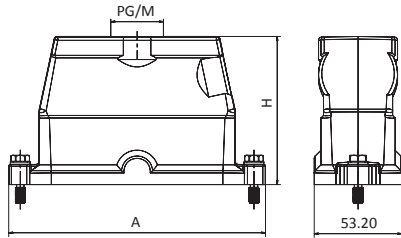
HBPM 对中锁定 (IP68) 系列

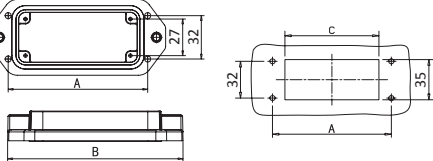
名称 Identification	规格 Size	型号 Type	订货号 Part No.	Metr.	比例图 Drawing	尺寸: 单位 Dimensions in mm																				
上壳 侧面进线 Hoods side entry 	H6BPM	H6BPM-TSH-M20	2410060510	20	 <table border="1" data-bbox="1046 713 1428 883"> <thead> <tr> <th>SIZE</th> <th>A</th> <th>H</th> </tr> </thead> <tbody> <tr> <td>H6BPM</td> <td>96</td> <td>70</td> </tr> <tr> <td>H10BPM</td> <td>110</td> <td>70</td> </tr> <tr> <td>H16BPM</td> <td>130</td> <td>80</td> </tr> <tr> <td>H24BPM</td> <td>156</td> <td>80</td> </tr> </tbody> </table>	SIZE	A	H	H6BPM	96	70	H10BPM	110	70	H16BPM	130	80	H24BPM	156	80						
	SIZE	A	H																							
	H6BPM	96	70																							
	H10BPM	110	70																							
	H16BPM	130	80																							
	H24BPM	156	80																							
	H6BPM	H6BPM-TSH-M25	2410060511	25																						
	H6BPM	H6BPM-TSH-M32	2410060512	32																						
	H6BPM	H6BPM-TSH-M40	2410060513	40																						
	H10BPM	H10BPM-TSH-M25	2410100511	25																						
	H10BPM	H10BPM-TSH-M32	2410100512	32																						
	H10BPM	H10BPM-TSH-M40	2410100513	40																						
	H16BPM	H16BPM-TSH-M25	2410160511	25																						
	H16BPM	H16BPM-TSH-M32	2410160512	32																						
	H16BPM	H16BPM-TSH-M40	2410160513	40																						
	H16BPM	H16BPM-TSH-M50	2410160514	50																						
H24BPM	H24BPM-TSH-M25	2410240511	25																							
H24BPM	H24BPM-TSH-M32	2410240512	32																							
H24BPM	H24BPM-TSH-M40	2410240513	40																							
H24BPM	H24BPM-TSH-M50	2410240514	50																							
上壳 顶部进线 Hoods top entry 	H6BPM	H6BPM-TGH-M20	2410060410	1×20	 <table border="1" data-bbox="1046 1360 1428 1530"> <thead> <tr> <th>SIZE</th> <th>A</th> <th>H</th> </tr> </thead> <tbody> <tr> <td>H6BPM</td> <td>96</td> <td>70</td> </tr> <tr> <td>H10BPM</td> <td>110</td> <td>70</td> </tr> <tr> <td>H16BPM</td> <td>130</td> <td>80</td> </tr> <tr> <td>H24BPM</td> <td>156</td> <td>80</td> </tr> </tbody> </table>	SIZE	A	H	H6BPM	96	70	H10BPM	110	70	H16BPM	130	80	H24BPM	156	80						
	SIZE	A	H																							
	H6BPM	96	70																							
	H10BPM	110	70																							
	H16BPM	130	80																							
	H24BPM	156	80																							
	H6BPM	H6BPM-TGH-M25	2410060411	1×25																						
	H6BPM	H6BPM-TGH-M32	2410060412	1×32																						
	H6BPM	H6BPM-TGH-M40	2410060413	1×40																						
	H10BPM	H10BPM-TGH-M25	2410100411	1×25																						
	H10BPM	H10BPM-TGH-M32	2410100412	1×32																						
	H10BPM	H10BPM-TGH-2M20	2410100430	2×20																						
	H16BPM	H16BPM-TGH-M25	2410160411	1×25																						
	H16BPM	H16BPM-TGH-M32	2410160412	1×32																						
	H16BPM	H16BPM-TGH-M40	2410160413	1×40																						
	H16BPM	H16BPM-TGH-M50	2410160414	1×50																						
H16BPM	H16BPM-TGH-2M25	2410160431	2×25																							
H24BPM	H24BPM-TGH-M32	2410240412	1×32																							
H24BPM	H24BPM-TGH-M40	2410240413	1×40																							
H24BPM	H24BPM-TGH-M50	2410240414	1×50																							
H24BPM	H24BPM-TGH-2M32	2410240432	2×32																							
H24BPM	H24BPM-TGH-2M40	2410240433	2×40																							
H24BPM	H24BPM-TGH-2M25	2410240461	3×25																							
下壳 开孔安装 Housings, bulkhead mounting 	H6BPM	H6BPM-AG	2410060311		 <table border="1" data-bbox="1046 1867 1428 2037"> <thead> <tr> <th>SIZE</th> <th>A</th> <th>B</th> <th>C</th> </tr> </thead> <tbody> <tr> <td>H6BPM</td> <td>70</td> <td>96</td> <td>48</td> </tr> <tr> <td>H10BPM</td> <td>83</td> <td>110</td> <td>60</td> </tr> <tr> <td>H16BPM</td> <td>103</td> <td>130</td> <td>82</td> </tr> <tr> <td>H24BPM</td> <td>130</td> <td>156</td> <td>108</td> </tr> </tbody> </table>	SIZE	A	B	C	H6BPM	70	96	48	H10BPM	83	110	60	H16BPM	103	130	82	H24BPM	130	156	108	
	SIZE	A	B	C																						
	H6BPM	70	96	48																						
	H10BPM	83	110	60																						
	H16BPM	103	130	82																						
H24BPM	130	156	108																							
H10BPM	H10BPM-AG	2410100311																								
H16BPM	H16BPM-AG	2410160311																								
H24BPM	H24BPM-AG	2410240311																								

IP68 特殊外壳

EMC 高防护外壳 METAL HOODS / HOUSINGS SERIES



HBHM 对中锁定 (IP68) 系列

名称 Identification	规格 Size	型号 Type	订货号 Part No.	Metr.	比例图 Drawing	尺寸: 单位 Dimensions in mm
上壳 侧面进线 Hoods side entry	H16BHM	H16BHM-TSH-M25	2420160511	25		
	H16BHM	H16BHM-TSH-M32	2420160512	32		
	H16BHM	H16BHM-TSH-M40	2420160513	40		
	H16BHM	H16BHM-TSH-M50	2420160514	50		
	H24BHM	H24BHM-TSH-M25	2420240511	25		
	H24BHM	H24BHM-TSH-M32	2420240512	32		
	H24BHM	H24BHM-TSH-M40	2420240513	40		
	H24BHM	H24BHM-TSH-M50	2420240514	50		
上壳 顶部进线 Hoods top entry	H16BHM	H16BHM-TGH-M25	2420160411	1×25		
	H16BHM	H16BHM-TGH-M32	2420160412	1×32		
	H16BHM	H16BHM-TGH-M40	2420160413	1×40		
	H16BHM	H16BHM-TGH-M50	2420160414	1×50		
	H16BHM	H16BHM-TGH-2M25	2420160431	2×25		
	H24BHM	H24BHM-TGH-M32	2420240412	1×32		
	H24BHM	H24BHM-TGH-M40	2420240413	1×40		
	H24BHM	H24BHM-TGH-M50	2420240414	1×50		
	H24BHM	H24BHM-TGH-2M32	2420240432	2×32		
	H24BHM	H24BHM-TGH-2M40	2420240433	2×40		
	H24BHM	H24BHM-TGH-2M25	2420240461	3×25		
	下壳 安装支架	H16BHM	H16BHM-AG	2420160311		
H24BHM		H24BHM-AG	2420240311			