

芯件导轨安装金属支架 INSERT RAIL MOUNTING ELEMENT

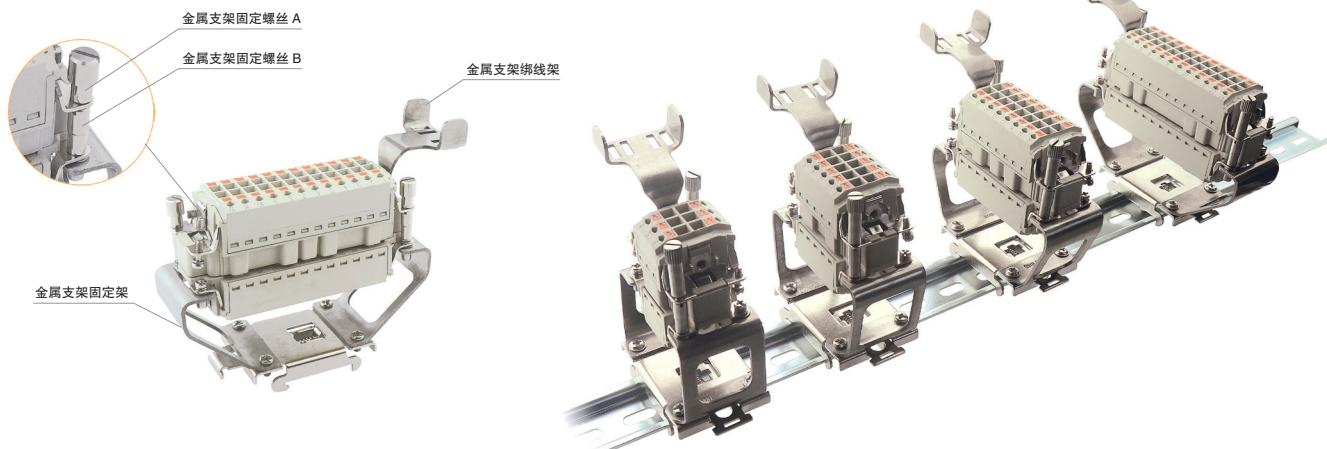

不含芯子	型号 Type	订货号 Part No.
柜内导轨安装金属支架 6B	SNAP-6B-S	2330000006
柜内导轨安装金属支架 10B	SNAP-10B-S	2330000010
柜内导轨安装金属支架 16B	SNAP-16B-S	2330000016
柜内导轨安装金属支架 24B	SNAP-24B-S	2330000024

系列	型号 Type	订货号 Part No.	型号 Type	订货号 Part No.	型号 Type	订货号 Part No.	型号 Type	订货号 Part No.
HE 16A 500V 6、10、16、24 芯	SNAP-HE-006-6B	2330000606	SNAP-HE-010-10B	2330001010	SNAP-HE-016-16B	2330001616	SNAP-HE-024-24B	2330002424
HESH 16A 500V 6、10、16、24 芯	SNAP-HESH-006-6B	2330010606	SNAP-HESH-010-10B	2330011010	SNAP-HESH-016-16B	2330011616	SNAP-HESH-024-24B	2330012424
HEC 16A 500V 6、10、16、24 芯	SNAP-HEC-006-6B	2330020606	SNAP-HEC-010-10B	2330021010	SNAP-HEC-016-16B	2330021616	SNAP-HEC-024-24B	2330022424
HEE 16A 500V 10、18、32、46 芯	SNAP-HEE-010-6B	2320001006	SNAP-HEE-018-10B	2320001810	SNAP-HEE-032-16B	2320003216	SNAP-HEE-046-24B	2320004624
HEEE 16A 400V 64、72 芯	/	/	/	/	SNAP-HEEE-064-16B	2320006416	SNAP-HEEE-072-24B	2320007224
HD 10A 250V 40、64 芯	/	/	/	/	SNAP-HD-040-16B	2210004016	SNAP-HD-064-24B	2210006424
HDD 10A 250V 24、42、72、108 芯	SNAP-HDD-024-6B	2160002406	SNAP-HDD-042-10B	2160004210	SNAP-HDD-072-16B	2160007216	SNAP-HDD-108-24B	2160010824
HSB 35A 690V 6 芯	/	/	/	/	SNAP-HSB-006-16B	2310000616	/	/

尺寸图 Dimension

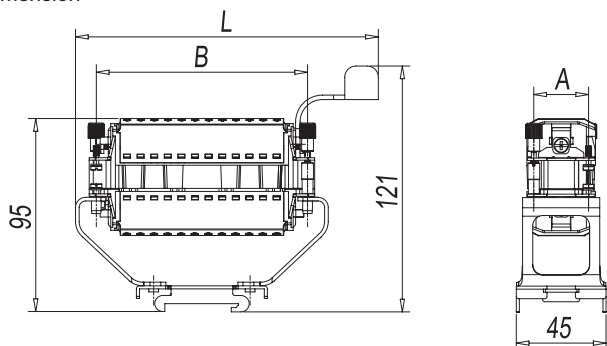

支架型号	L (mm)	A (mm)	B (mm)
SNAP-6B-S	89	27	44
SNAP-10B-S	102	27	57
SNAP-16B-S	122	27	77.5
SNAP-24B-S	149	27	104

金属导轨安装支架步骤



1: 导轨支架

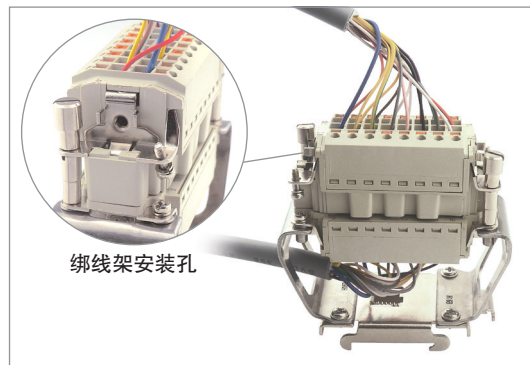

5: 插入公插。

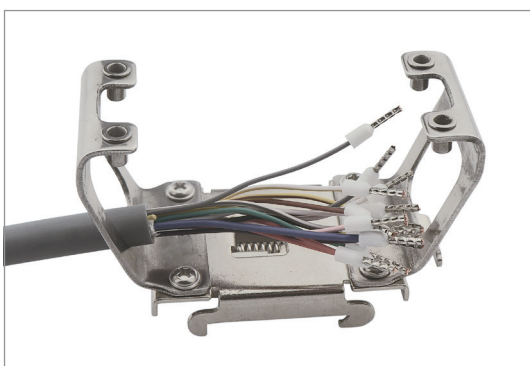

2: 穿线

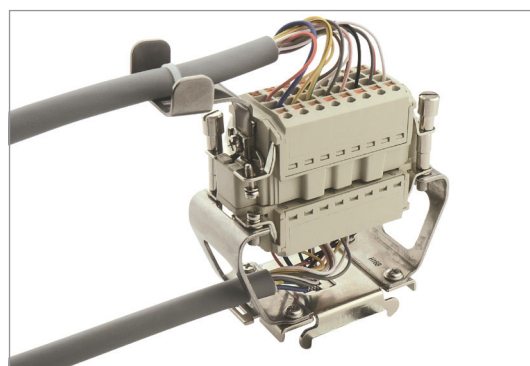

6: 安装绑线架

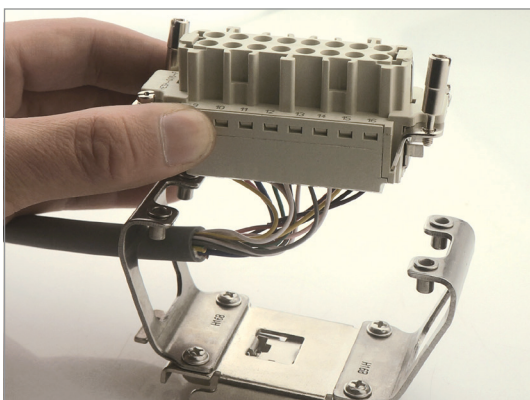

3: 母接插件装相应线束

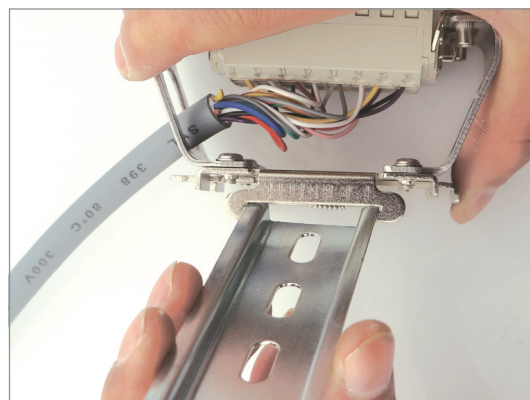

7: 卡入导轨

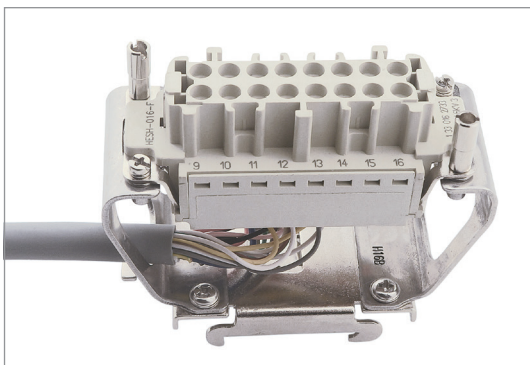

4: 装入导轨支架，锁紧螺丝。

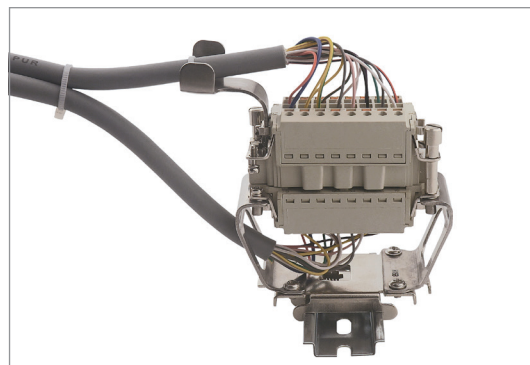

8: 完成安装

芯件导轨安装支架 INSERT RAIL MOUNTING ELEMENT

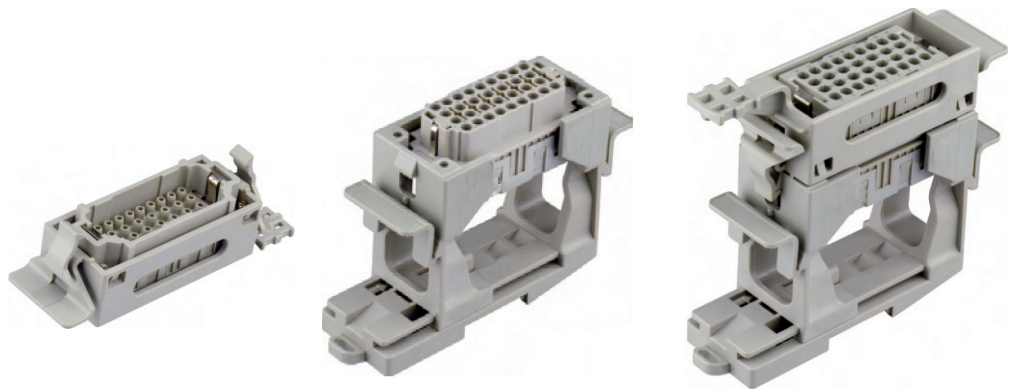

导轨安装支架套件 Insert mounting with carrier element

套件包括：导轨安装底座及上部固定架 Set include: Top and base frame

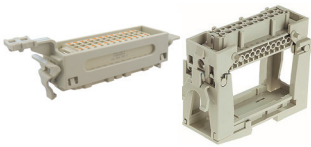
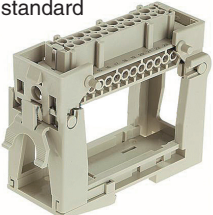
	型号 Type	订货号 Part No.		型号 Type	订货号 Part No.
上 Top  内部接插件需单独订购 Internal connectors should be ordered separately	SPSB-TOP-6B	2 33 000 9927	 内部接插件需单独订购 Internal connectors should be ordered separately	SNAP-6B	2 33 000 9991
	SPSB-TOP-10B	2 33 000 9947		SNAP-10B	2 33 000 9993
	SPSB-TOP-16B	2 33 000 9967		SNAP-16B	2 33 000 9995
	SPSB-TOP-24B	2 33 000 9987		SNAP-24B	2 33 000 9997
下 Base 标准 standard  内部接插件需单独订购 Internal connectors should be ordered separately	SPSB-BASE-6B	2 33 000 9806			
	SPSB-BASE-10B	2 33 000 9810			
	SPSB-BASE-16B	2 33 000 9816			
	SPSB-BASE-24B	2 33 000 9824			

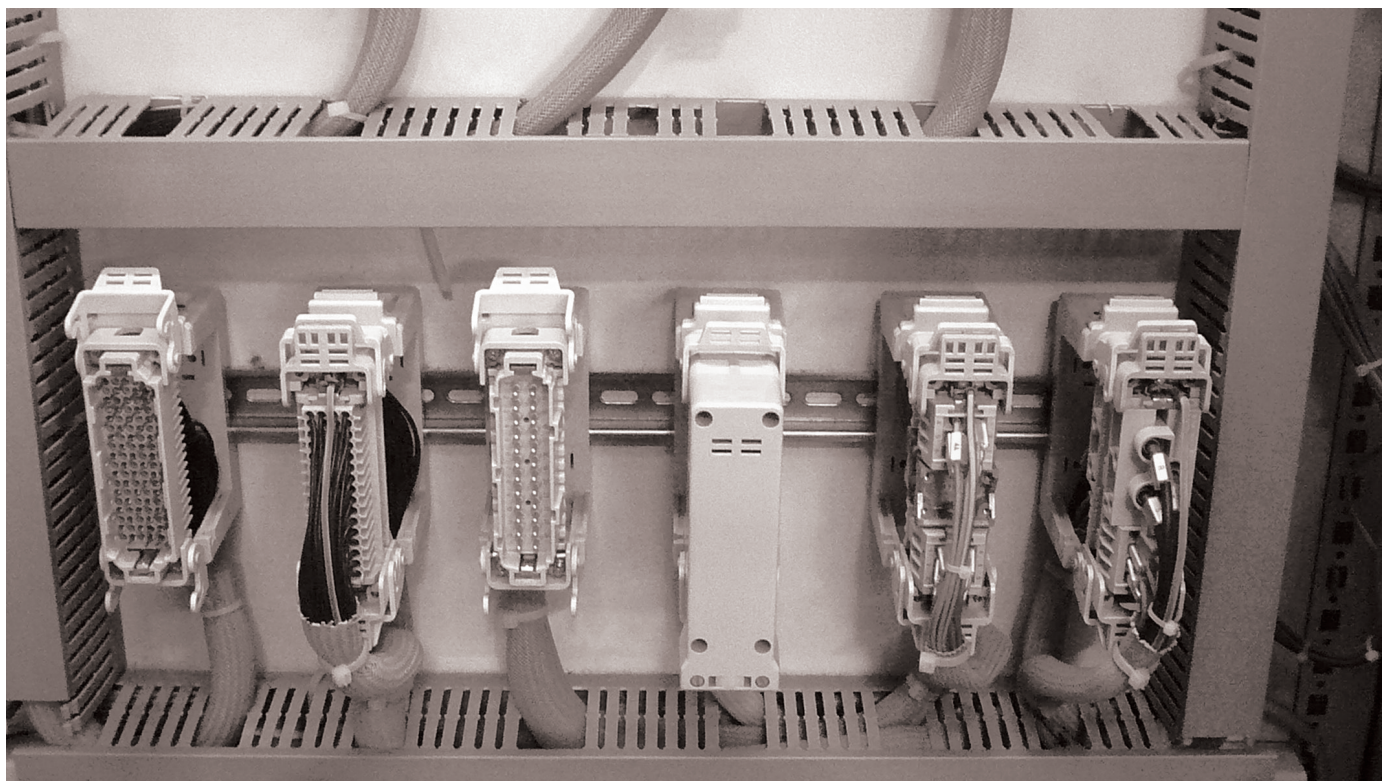

安装附件 INSTALLATION ELEMENTS

编码销系列 Coding element series (导向销 with guide pins)

编码块 Encoding profile

防插错编码块，最多可编码区分 6 个相同位数的连接器
适用于 for 16、24 芯



订货号 Part No. 1300009900

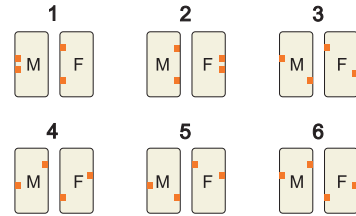
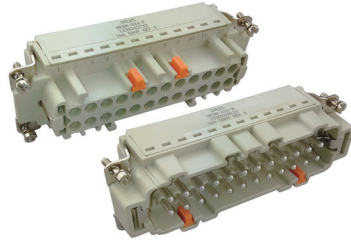

编码销 / 导向销 (单个使用)
Standard code pin

编码销应在插头和插座中对应使用，编码形式如下图
For hood / housing with one insert / one frame

标准 Standard



模块专用 Module is special

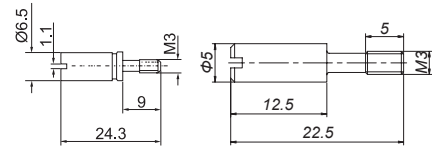

标准 Standard: 1300009901

模块专用 Module is special: 1300009902

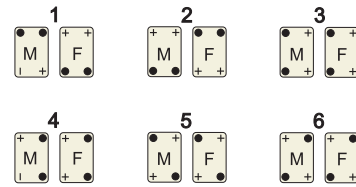
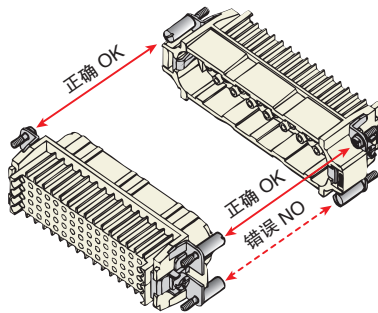

编码销 / 导向销 (带导向孔)

Standard code pin (with guide pins)



编码销 M

编码销 F

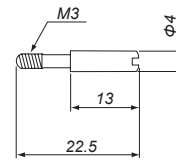

编码销 M

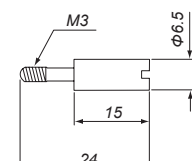

编码销 F

编码销 M 1300009908

编码销 F 1300009909

