

连接器定义形式 CONNECTOR DEFINITION FORM

单端预铸线束规格定义 With open ended wires

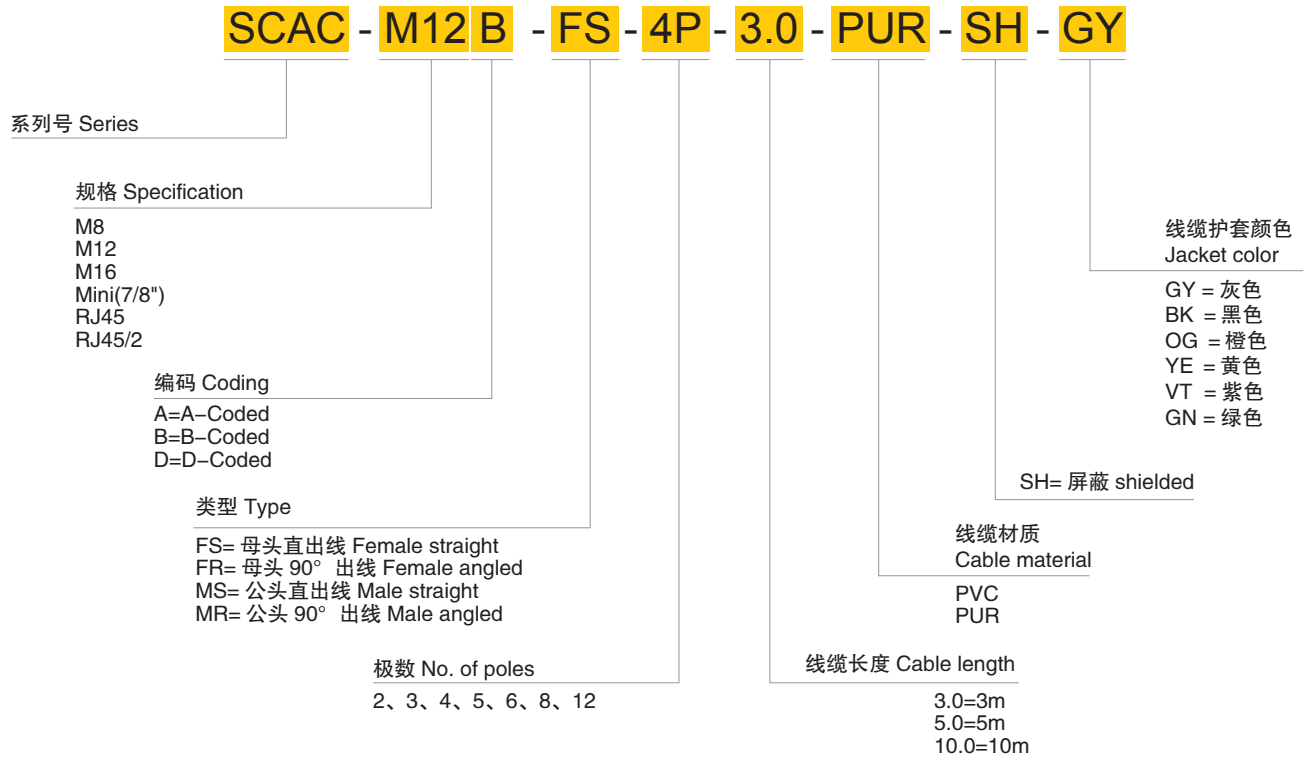

双端预铸线束规格定义 Connection cable

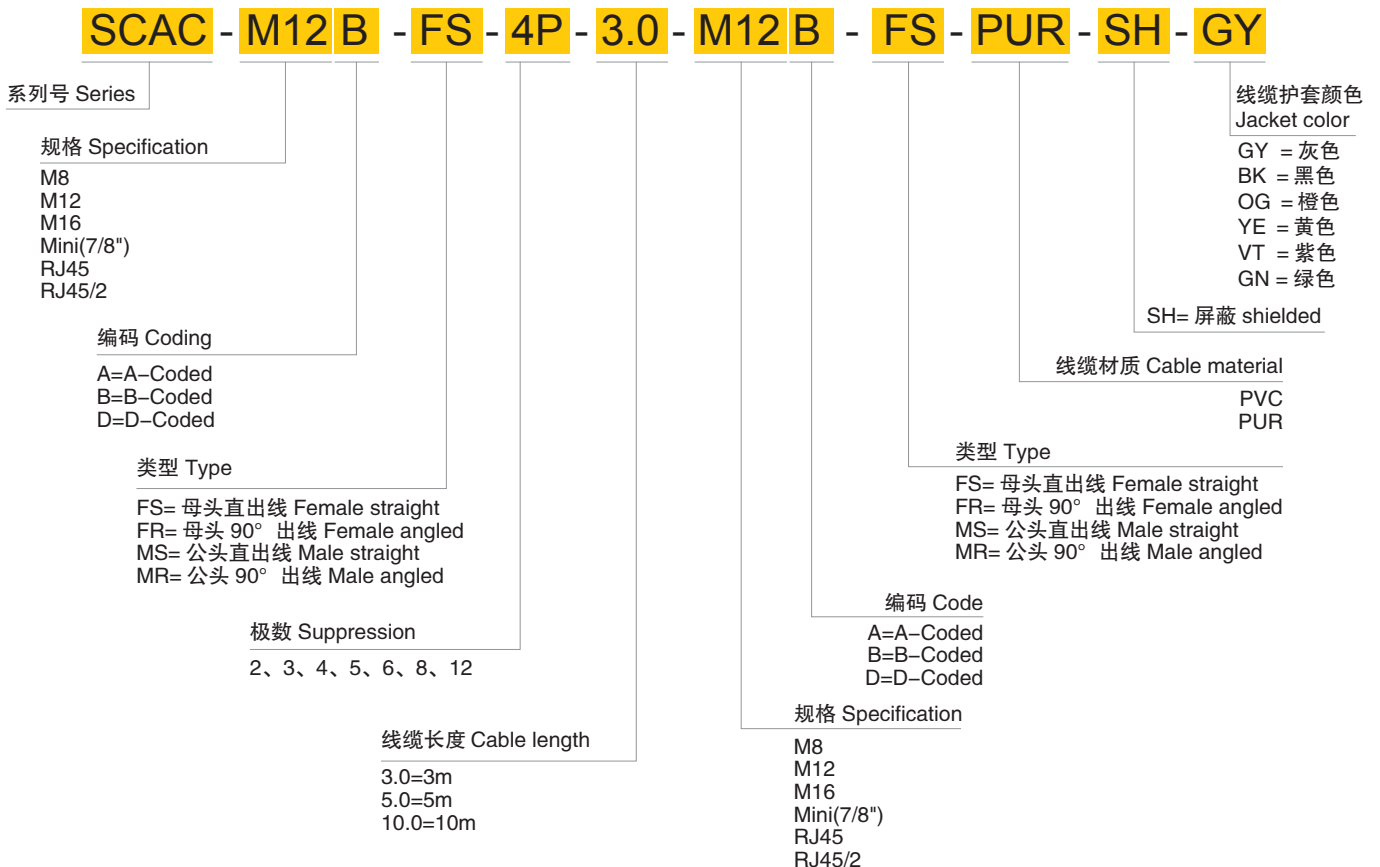

连接器定义形式 CONNECTOR DEFINITION FORM

现场接线连接器型号定义 Plug connectors for fieldbus technology

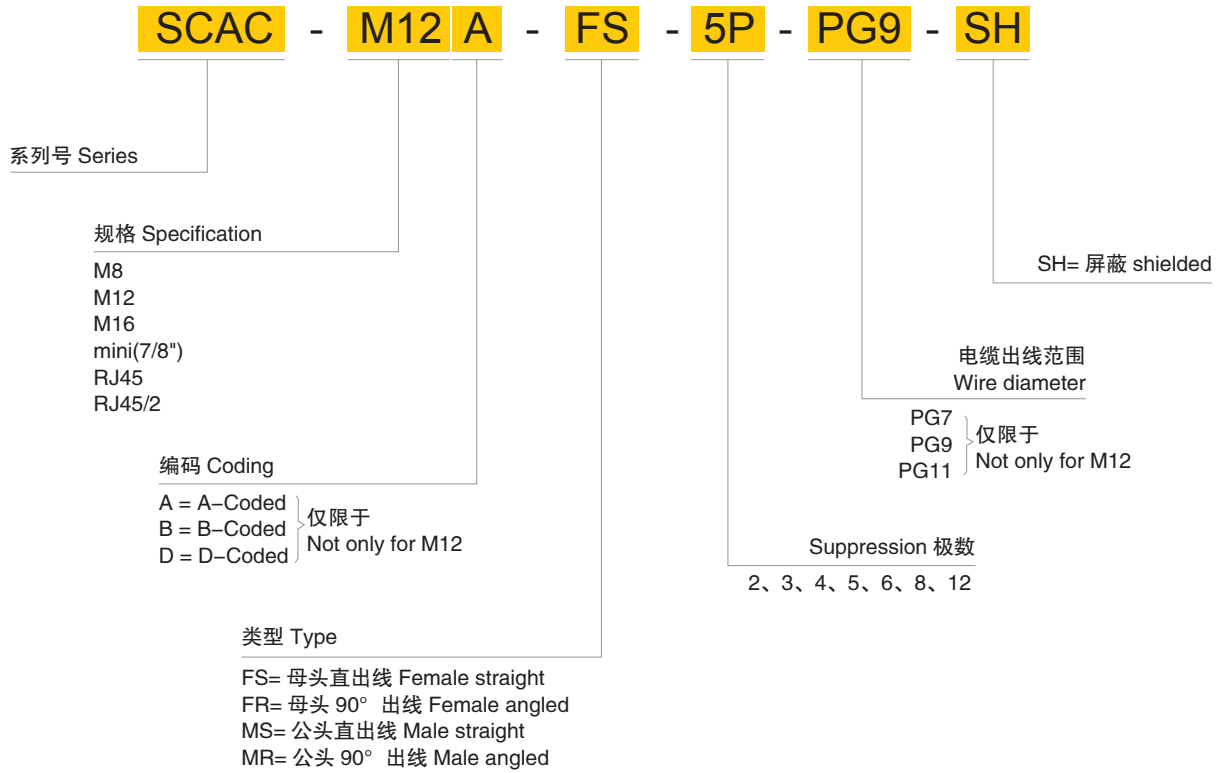

板面安装插座型号定义 Panel installed connectors

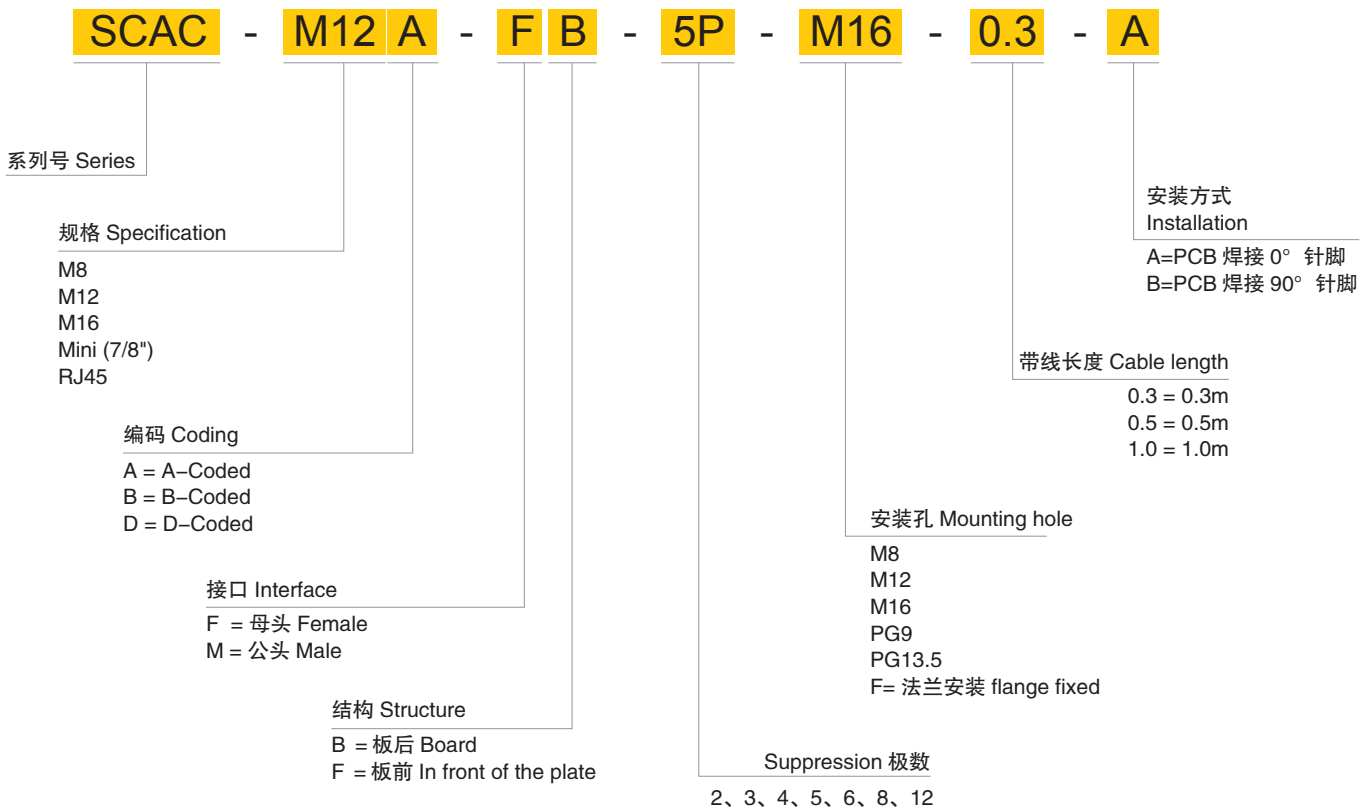

M5 圆形连接器 ROUND PLUG CONNECTOR

类型		订货号 Part No.
	3-pole 单端预铸, 插针 4-pole 单端预铸, 插针	905001-610-xxxx 905011-611-xxxx
	3-pole 单端预铸, 插孔 4-pole 单端预铸, 插孔	905041-610-xxxx 905061-611-xxxx
	3-pole 双端预铸, 插针转插孔 4-pole 双端预铸, 插针转插孔	955001-610-xxxx 955011-611-xxxx
	3-pole 法兰安装, 插针 4-pole 法兰安装, 插针	905551-xxxx 905561-xxxx
	3-pole 法兰安装, 插孔 4-pole 法兰安装, 插孔	905571-xxxx 905581-xxxx
	3-pole 法兰安装 PCB, 插针 4-pole 法兰安装 PCB, 插针	905551P 905561P
	3-pole 法兰安装 PCB, 插孔 4-pole 法兰安装 PCB, 插孔	905571P 905581P

M12 圆形连接器 ROUND PLUG CONNECTOR

现场接线 Field-wireable



M12 圆形连接器 Round plug connector

插针 Male

- 直出线 / 90°
Straight / 90°

插孔 Female

- 直出线 / 90°
Straight / 90°

页次 page 5.2.1



M12 圆形连接器 Round plug connector 屏蔽 Shielded

插针 Male

- 直出线 / 90°
Straight / 90°

插孔 Female

- 直出线 / 90°
Straight / 90°

页次 page 5.2.4

单端预铸线束 With open ended wires

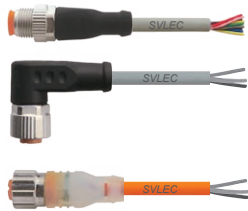

M12 圆形连接器 Round plug connector

插针 Male

- 直出线 Straight

插孔 Female

- 90°

插孔 Female 带 With LED

页次 page 5.2.7



M12 圆形连接器 Round plug connector

插针 Male

- 直出线 Straight

屏蔽 Shielded

- 90°

页次 page 5.2.17

双端预铸线束 Connection cable



M12 圆形连接器 Round plug connector

插针 Male

- 直出线 Straight
- 90°

M12 圆形连接器 Round plug connector

插孔 Female

- 直出线 Straight
- 90°

页次 page 5.2.21

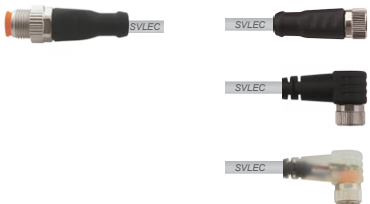

M12 圆形连接器 Round plug connector

插针 Male

- 直出线 Straight

M8 圆形连接器 Round plug connector

插孔 Female

- 直出线 Straight
- 90°
- 90° 带 With LED

页次 page 5.2.25



M12 圆形连接器 Round plug connector

插针 Male

- 直出线 Straight

M12 圆形连接器 Round plug connector

插孔 Female

- 90°
- 90° 带 With LED

页次 page 5.2.27

M12 圆形连接器 ROUND PLUG CONNECTOR

双端预铸线束 Connection cable

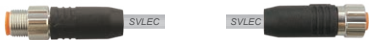

M12 圆形连接器 Round plug connector
 插针 Male • 直出线 Straight
 屏蔽 Shielded

M12 圆形连接器 Round plug connector
 插孔 Female • 直出线 Straight
 屏蔽 Shielded • 90°

页次 page 5.2.29

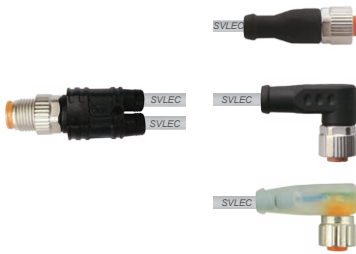

M12 圆形连接器 Round plug connector-Y 型线
 插针 Male • 直出线 Straight

M12 圆形连接器 Round plug connector
 插孔 Female • 直出线 Straight
 • 90°
 • 90° 带 With LED

页次 page 5.2.31



M12 圆形连接器 Round plug connector-Y 型线
 插针 Male • 直出线 Straight

M8 圆形连接器 Round plug connector
 插孔 Female • 直出线 Straight
 • 90°
 • 90° 带 With LED

页次 page 5.2.35

M12 板面安装插座 Panel installed connectors



板后安装连接器 Panel installed connectors

插针、插孔 4-pole A-coded、B-coded、D-coded
 Male / Female 5-pole A-coded、B-coded
 8-pole B-coded

页次 page 5.2.36



板前安装连接器 Panel installed connectors

插针、插孔 4-pole A-coded、B-coded、D-coded
 Male/Female 5-pole A-coded、B-coded
 8-pole B-coded

页次 page 5.2.38



印制电路板安装连接器 PCB connectors

插针、插孔 4-pole A-coded、B-coded、D-coded
 Male/Female 5-pole A-coded、B-coded
 8-pole B-coded

页次 page 5.2.40



PCB 安装连接器 Install the connector for

插针、插孔 90° 4-pole
 Male / Female 90° 5-pole

页次 page 5.2.41



控制柜引入系统 Control cabinet entry system

插针、插孔 4-pole D-coded
 Male/Female 5-pole B-coded • 对应 Profibus-DP and Interbus

页次 page 5.2.42

M12 圆形连接器 ROUND PLUG CONNECTOR

现场接线
Field-wireable











螺钉压接
With screw terminals

插针 Male
直出 Straight



插孔 Female
直出 Straight

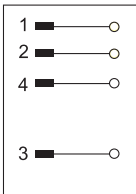
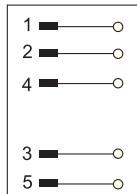
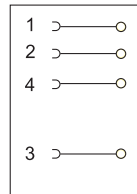
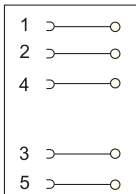
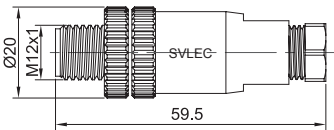
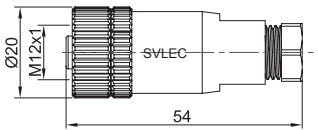

1	极数 Suppression	4-pole		5-pole		4-pole		5-pole	
	A-Coded 订货号 Part No.	912701 912741		912721 912761		912901 912941		912921 912961	
螺钉压接 With screw terminals	912701 912741		912721 912761		912901 912941		912921 912961		
针脚排序 Contact layout									
B-Coded 订货号 Part No.	913093		914002		913703		914003		
螺钉压接 With screw terminals	913093		914002		913703		914003		
针脚排序 Contact layout									
D-Coded 订货号 Part No.	914007				914008				
螺钉压接 With screw terminals	914007				914008				
针脚排序 Contact layout									
压线范围 Wire diameter	4...6 mm	6...8 mm	4...6 mm	6...8 mm	4...6 mm	6...8 mm	4...6 mm	6...8 mm	
电路图 Circuit diagram									
2 技术参数 Technical data	250 V AC/DC		125 V AC/DC		250 V AC/DC		125 V AC/DC		
额定电压 Supply voltage	250 V AC/DC		125 V AC/DC		250 V AC/DC		125 V AC/DC		
额定电流 Current per contact (40°C)	max. 4 A		max. 4 A		max. 4 A		max. 4 A		
压线范围 Connection diameter	最大 max. 0.75 mm ²		最大 max. 0.75 mm ²		最大 max. 0.75 mm ²		最大 max. 0.75 mm ²		
外壳材料 Housing material	阻燃塑料 Flame retardant plastic		阻燃塑料 Flame retardant plastic		阻燃塑料 Flame retardant plastic		阻燃塑料 Flame retardant plastic		
防护等级 Protection	IP67- 插孔插针配合拧紧 (EN 60529) When plugged and screwed down		IP67- 插孔插针配合拧紧 (EN 60529) When plugged and screwed down		IP67- 插孔插针配合拧紧 (EN 60529) When plugged and screwed down		IP67- 插孔插针配合拧紧 (EN 60529) When plugged and screwed down		
温度范围 Temperature range	-25...+85°C		-25...+85°C		-25...+85°C		-25...+85°C		
尺寸图 Description									
订货号 Part No.	912701 912741		912721 912761		912901 912941		912921 912961		
可参考: 5.0.1 Reference: 5.0.1	912701 912741		912721 912761		912901 912941		912921 912961		
1 型号 Form	912701 912741		912721 912761		912901 912941		912921 912961		
备注 Notes	912701 912741		912721 912761		912901 912941		912921 912961		
配件及技术参数页面 Accessories and technical page: 5.2.43	912701 912741		912721 912761		912901 912941		912921 912961		

M12 圆形连接器 ROUND PLUG CONNECTOR

现场接线
Field-wireable

螺钉压接
With screw terminals

插针 Male
90°



插孔 Female
90°



1	极数 Suppression	4-pole		5-pole		4-pole		5-pole	
	A-Coded 订货号 Part No.	912821 912861		912841 912881		912981 913021		913001 913041	
螺钉压接 With screw terminals	912821 912861		912841 912881		912981 913021		913001 913041		
针脚排序 Contact layout									
B-Coded 订货号 Part No.	912071		912171		913701		913171		
螺钉压接 With screw terminals	912071		912171		913701		913171		
针脚排序 Contact layout									
D-Coded 订货号 Part No.	914471				914571				
螺钉压接 With screw terminals	914471				914571				
针脚排序 Contact layout									
压线范围 Wire diameter	4...6 mm	6...8 mm	4...6 mm	6...8 mm	4...6 mm	6...8 mm	4...6 mm	6...8 mm	
电路图 Circuit diagram									
2 技术参数 Technical data	250 V AC/DC		125 V AC/DC		250 V AC/DC		125 V AC/DC		
额定电压 Supply voltage	250 V AC/DC		125 V AC/DC		250 V AC/DC		125 V AC/DC		
额定电流 Current per contact (40°C)	max. 4 A								
压线范围 Connection diameter	最大 max. 0.75 mm ²								
外壳材料 Housing material	阻燃塑料 Flame retardant plastic								
防护等级 Protection	IP67- 插孔插针配合拧紧 (EN 60529) When plugged and screwed down								
温度范围 Temperature range	-25...+85°C								
尺寸图 Description									
订货号 Part No.	-----		-----		-----		-----		
可参考: 5.0.1 Reference: 5.0.1	-----		-----		-----		-----		
	1 型号 Form								
备注 Notes	配件及技术参数页面 Accessories and technical page: 5.2.43								

M12 圆形连接器

M12 圆形连接器 ROUND PLUG CONNECTOR

现场接线
Field-wireable

螺钉压接
With screw terminals

插针 Male
直出 Straight



插孔 Female
直出 Straight



1 型号 Form No. 917301 917321

极数
Suppression

8-pole

8-pole

插针 Male
90°



插孔 Female
90°



90° 型号 Form No. 917311 917331

极数
Suppression

8-pole

8-pole

电路图
Circuit diagram

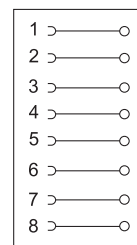
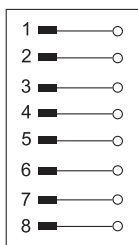

压线范围 Wire diameter

6...8 mm

6...8 mm

针脚排序
Contact layout

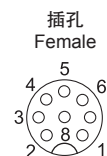
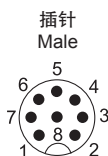

2 技术参数 Technical data

额定电压 Supply voltage

60 V AC/DC

额定电流 Current per contact (40°C)

max. 2 A

压线范围 Connection diameter

最大 max. 0.5 mm²

外壳材料 Housing material

阻燃塑料 Flame retardant plastic

压线方式 Wiring method

螺钉压接 Screw terminals

防护等级 Protection

IP67- 插孔插针配合拧紧 (EN 60529) When plugged and screwed down

温度范围 Temperature range

-25...+85°C

订货号 Part No.

可参考: 5.0.1
Reference: 5.0.1



1 型号 Form

备注 Notes

配件及技术参数页面 Accessories and technical page: 5.2.43

M12 圆形连接器 ROUND PLUG CONNECTOR

现场接线
Field-wireable
螺钉压接
With screw terminals
屏蔽
Shielded

插针 Male
直出 Straight



插孔 Female
直出 Straight



1	极数 Suppression	4-pole	5-pole	4-pole	5-pole
	A-Coded 订货号 Part No.				
	螺钉压接 With screw terminals	913301	913321	913381	913401
	针脚排序 Contact layout				
	B-Coded 订货号 Part No.				
	螺钉压接 With screw terminals		914001		914021
	针脚排序 Contact layout				
	D-Coded 订货号 Part No.				
	螺钉压接 With screw terminals	914521		914621	
	针脚排序 Contact layout				
	压线范围 Wire diameter	4...6 mm	6...8 mm	4...6 mm	6...8 mm
	电路图 Circuit diagram				
2	技术参数 Technical data				
	额定电压 Supply voltage	125 V AC/DC			
	额定电流 Current per contact (40°C)	max. 4 A			
	压线范围 Connection diameter	最大 max. 0.75 mm ²			
	外壳材料 Housing material	铜锌合金, 表面镀镍 CuZn, nickel plated			
	压线方式 Wiring method	螺钉压接 Screw terminals			
	防护等级 Protection	IP67- 插孔插针配合拧紧 (EN 60529) When pluggde and screwed down			
	温度范围 Temperature range	-25...+85°C			
	尺寸图 Description				
	订货号 Part No.				
	可参考: 5.0.1 Reference: 5.0.1	-----			
	1 型号 Form				
	备注 Notes				
		配件及技术参数页面 Accessories and technical page: 5.2.43			

M12 圆形连接器

M12 圆形连接器 ROUND PLUG CONNECTOR

现场接线
Field-wireable
螺钉压接
With screw terminals
屏蔽
Shielded

插针 Male
90°



插孔 Female
90°



1	极数 Suppression	4-pole	5-pole	4-pole	5-pole
	A-Coded 订货号 Part No.	913341	913361	913421	913441
	针脚排序 Contact layout				
	B-Coded 订货号 Part No.		914011		914031
	针脚排序 Contact layout				
	D-Coded 订货号 Part No.	914581		914661	
	针脚排序 Contact layout				
	压线范围 Wire diameter	4...6 mm	6...8 mm	4...6 mm	6...8 mm
	电路图 Circuit diagram				
2	技术参数 Technical data				
	额定电压 Supply voltage	125 V AC/DC			
	额定电流 Current per contact (40°C)	max. 4 A			
	压线范围 Connection diameter	最大 max. 0.75 mm ²			
	外壳材料 Housing material	铜锌合金, 表面镀镍 CuZn, nickel plated			
	压线方式 Wiring method	螺钉压接 Screw terminals			
	防护等级 Protection	IP67- 插孔插针配合拧紧 (EN 60529) When plugged and screwed down			
	温度范围 Temperature range	-25...+85°C			
	尺寸图 Description				
	订货号 Part No.				
	可参考: 5.0.1 Reference: 5.0.1				
		1 型号 Form			
	备注 Notes	配件及技术参数页面 Accessories and technical page: 5.2.43			

M12 圆形连接器 ROUND PLUG CONNECTOR

现场接线
Field-wireable
螺钉压接
With screw terminals
屏蔽
Shielded

插针 Male
直出 Straight



插孔 Female
直出 Straight



1 型号 Form No. 917341 917361

极数
Suppression

8-pole

8-pole

插针 Male
90°



插孔 Female
90°



90° 型号 Form No. 917351 917371

极数
Suppression

8-pole

8-pole

电路图
Circuit diagram

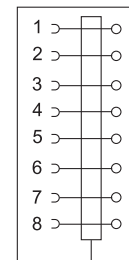
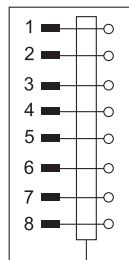

压线范围 Wire diameter 6...8mm

针脚排序
Contact layout

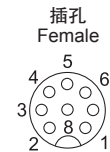
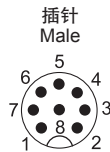

2 技术参数 Technical data

额定电压 Supply voltage	60 V AC/DC
额定电流 Current per contact (40°C)	2A
压线范围 Connection diameter	最大 max. 0.5 mm ²
外壳材料 Housing material	铜锌合金, 表面镀镍 CuZn, nickel plated
压线方式 Wiring method	螺钉压接 Screw terminals
防护等级 Protection	IP67- 插孔插针配合拧紧 (EN 60529) When pluggde and screwed down
温度范围 Temperature range	-25...+85°C

订货号 Part No.

可参考: 5.0.1
Reference: 5.0.1



1 型号 Form

备注 Notes



配件及技术参数页面 Accessories and technical page: 5.2.43

M12 圆形连接器 ROUND PLUG CONNECTOR

单端预铸线束
With open ended wires

插针 Male
直出 Straight

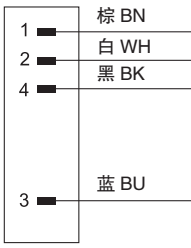
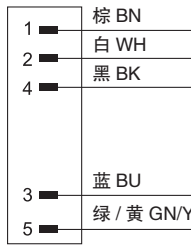

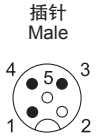
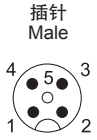
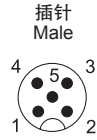
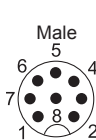
1	型号 Form No.	912001	912021	912041	917001			
	食品和饮料 FOOD & BEVERAGE	912001F	912021F	912041F	917001F			
	极数 Suppression	3-pole	4-pole	5-pole	8-pole			
	电路图 Circuit diagram							
	针脚排序 Contact layout							
2	电缆类型 Cable type	护套颜色 Jacket color						
	导体横截面 0.34mm ²	灰 GY	黑 BK	黄 YE	灰 GY	黑 BK	灰 GY	黑 BK
	PVC	213	613		214	614	215	615
	PUR	223	623		224	624	225	625
	PUR 高柔性 Highly flexible		633			634		635
	抗扭、防飞溅 Torsion, welding spark resistant			154 054				
	导体横截面 0.5mm ² (抗扭、防飞溅)			174				
	导体横截面 0.25mm ²						灰 GY	
	PVC						292	
	PUR						295	
3	电缆长度 Cable length							
	1.5m	0150						
	3.0m	0300						
	5.0m	0500						
	7.5m	0750						
	10.0m	1000						
	订货号 Part No.							
	可参考: 5.0.1 Reference: 5.0.1	例: <u>912001</u> - <u>213</u> - <u>0500</u>						
		1 型号 Form	2 电缆类型 Cable type	3 电缆长度 Cable length				
	备注 Notes	电缆参数 Cable parameter: 5.0.1 配件页面 Accessories on page: 5.2.43 不同的电缆长度可根据实际需要, 在订货号的第三部分自行修改, 电缆长度单位: cm						

M12 圆形连接器 ROUND PLUG CONNECTOR

单端预铸线束
With open ended wires

插针 Male
直出 Straight



M12 圆形连接器

1	型号 Form No.	919001	927001
	食品和饮料 FOOD & BEVERAGE	919001F	927021F
	极数 Suppression	12-pole	17-pole
	电路图 Circuit diagram		
	针脚排序 Contact layout	<p>插针 Male</p>	<p>插针 Male</p>
	2	电缆类型 Cable type	护套颜色 Jacket color
	导体横截面 0.25mm ²	灰 GY	
	PUR 高柔性 Highly flexible	301	
	导体横截面 0.14mm ²	黑 BK	黑 BK
	PVC	702	742
	PUR 高柔性 Highly flexible	705	745
3	电缆长度 Cable length		
	1.5m	0150	
	3.0m	0300	
	5.0m	0500	
	7.5m	0750	
	10.0m	1000	
	技术参数 Technical data		
	工作电压 Supply voltage	max. 30 V AC/DC	
	防护等级 Protection	IP67- 插孔插针配合拧紧 (EN 60529) When plugged and screwed down	
	温度范围 Temperature range	-25...+85°C	
	订货号 Part No.		
	可参考: 5.0.1 Reference: 5.0.1	<p>例: <u> 919001 </u> - <u> 301 </u> - <u> 0500 </u></p>	
		1 型号 Form	2 电缆类型 Cable type
			3 电缆长度 Cable length
	备注 Notes		
		电缆参数 Cable parameter: 5.0.1 配件及技术页面 Accessories and technical page: 5.2.43 不同的电缆长度可根据实际需要, 在订货号的第三部分自行修改, 电缆长度单位: cm	

M12 圆形连接器 ROUND PLUG CONNECTOR

单端预铸线束
 With open ended wires

插针 Male
 90°



1	型号 Form No.	912081	912101	912121	917021			
	食品和饮料 FOOD & BEVERAGE	912081F	912101F	912121F	917021F			
	极数 Suppression	3-pole	4-pole	5-pole	8-pole			
	电路图 Circuit diagram							
	针脚排序 Contact layout							
2	电缆类型 Cable type	护套颜色 Jacket color						
	导体横截面 0.34mm ²	灰 GY	黑 BK	黄 YE	灰 GY	黑 BK	灰 GY	黑 BK
	PVC	213	613		214	614	215	615
	PUR	223	623		224	624	225	625
	PUR 高柔性 Highly flexible		633		634		635	
	抗扭、防飞溅 Torsion, welding spark resistant			154 054				
	导体横截面 0.5mm ² (抗扭、防飞溅)			174				
	导体横截面 0.25mm ²						灰 GY	
	PVC						292	
	PUR						295	
3	电缆长度 Cable length							
	1.5m	0150						
	3.0m	0300						
	5.0m	0500						
	7.5m	0750						
	10.0m	1000						
	订货号 Part No.							
	可参考: 5.0.1 Reference: 5.0.1	例: <u> 912081 </u> — <u> 213 </u> — <u> 0500 </u>						
		1 型号 Form	2 电缆类型 Cable type	3 电缆长度 Cable length				
	备注 Notes	电缆参数 Cable parameter: 5.0.1 配件页面 Accessories on page: 5.2.43 不同的电缆长度可根据实际需要, 在订货号的第三部分自行修改, 电缆长度单位: cm						

M12 圆形连接器

M12 圆形连接器 ROUND PLUG CONNECTOR

单端预铸线束
With open ended wires

插针 Male
90°



M12 圆形连接器

1	型号 Form No.	919021	927021
	食品和饮料 FOOD & BEVERAGE	919021F	927021F
极数 Suppression		12-pole	17-pole
	电路图 Circuit diagram		
引脚排序 Contact layout			
	2	电缆类型 Cable type	护套颜色 Jacket color
	导体横截面 0.25mm ²	灰 GY	
	PUR 高柔性 Highly flexible	301	
	导体横截面 0.14mm ²	黑 BK	黑 BK
	PVC	702	742
	PUR 高柔性 Highly flexible	705	745
3	电缆长度 Cable length		
	1.5m	0150	
	3.0m	0300	
	5.0m	0500	
	7.5m	0750	
	10.0m	1000	
技术参数 Technical data	工作电压 Supply voltage	max. 30 V AC/DC	
	防护等级 Protection	IP67- 插孔插针配合拧紧 (EN 60529) When plugged and screwed down	
	温度范围 Temperature range	-25...+85°C	
订货号 Part No.			
	可参考: 5.0.1 Reference: 5.0.1	例: <u> 919021 </u> - <u> 301 </u> - <u> 0500 </u>	
	1	2	3
	型号 Form	电缆类型 Cable type	电缆长度 Cable length
备注 Notes	电缆参数 Cable parameter: 5.0.1 配件及技术页面 Accessories and technical page: 5.2.43 不同的电缆长度可根据实际需要, 在订货号的第三部分自行修改, 电缆长度单位: cm		

M12 圆形连接器 ROUND PLUG CONNECTOR

单端预铸线束
 With open ended wires

插孔 Female
 直出 Straight



1	型号 Form No.	912181	912221	912241	917041			
	食品和饮料 FOOD & BEVERAGE	912181F	912221F	912241F	917041F			
	极数 Suppression	3-pole	4-pole	5-pole	8-pole			
	电路图 Circuit diagram							
	针脚排序 Contact layout							
2	电缆类型 Cable type	护套颜色 Jacket color						
	导体横截面 0.34mm ²	灰 GY	黑 BK	黄 YE	灰 GY	黑 BK	灰 GY	黑 BK
	PVC	213	613		214	614	215	615
	PUR	223	623		224	624	225	625
	PUR 高柔性 Highly flexible		633			634		635
	抗扭、防飞溅 Torsion, welding spark resistant			154 054				
	导体横截面 0.5mm ² (抗扭、防飞溅)			174				
	导体横截面 0.25mm ²						灰 GY	
	PVC						292	
	PUR						295	
3	电缆长度 Cable length							
	1.5m	0150						
	3.0m	0300						
	5.0m	0500						
	7.5m	0750						
	10.0m	1000						
	订货号 Part No.							
	可参考: 5.0.1 Reference: 5.0.1	例: <u> 912281 </u> — <u> 213 </u> — <u> 0500 </u>						
		1	型号 Form	2	电缆类型 Cable type	3	电缆长度 Cable length	
	备注 Notes							
		电缆参数 Cable parameter: 5.0.1 配件页面 Accessories on page: 5.2.43 不同的电缆长度可根据实际需要, 在订货号的第三部分自行修改, 电缆长度单位: cm						

M12 圆形连接器 ROUND PLUG CONNECTOR

单端预铸线束
With open ended wires

插孔 Female
直出 Straight



M12 圆形连接器

1 型号 Form No.	919041	927041
	食品和饮料 FOOD & BEVERAGE 919041F	927061F
极数 Suppression	12-pole	17-pole
电路图 Circuit diagram		
针脚排序 Contact layout	<p>插孔 Female</p>	<p>插孔 Female</p>
2 电缆类型 Cable type	护套颜色 Jacket color	
导体横截面 0.25mm ²	灰 GY	
PUR 高柔性 Highly flexible	301	
导体横截面 0.14mm ²	黑 BK	黑 BK
PVC	702	742
PUR 高柔性 Highly flexible	705	745
3 电缆长度 Cable length		
1.5m	0150	
3.0m	0300	
5.0m	0500	
7.5m	0750	
10.0m	1000	
技术参数 Technical data		
工作电压 Supply voltage	max. 30 V AC/DC	
防护等级 Protection	IP67- 插孔插针配合拧紧 (EN 60529) When plugged and screwed down	
温度范围 Temperature range	-25...+85°C	
订货号 Part No.		
可参考: 5.0.1 Reference: 5.0.1	例: <u> 919041 </u> - <u> 301 </u> - <u> 0500 </u>	
	1 型号 Form	2 电缆类型 Cable type
		3 电缆长度 Cable length
备注 Notes		
	电缆参数 Cable parameter: 5.0.1 配件及技术页面 Accessories and technical page: 5.2.43 不同的电缆长度可根据实际需要, 在订货号的第三部分自行修改, 电缆长度单位: cm	

M12 圆形连接器 ROUND PLUG CONNECTOR

单端预铸线束
 With open ended wires

插孔 Female
 90°



1	型号 Form No.	912321	912341	912361	917061			
	食品和饮料 FOOD & BEVERAGE	912321F	912341F	912361F	917061F			
	极数 Suppression	3-pole	4-pole	5-pole	8-pole			
	电路图 Circuit diagram							
	针脚排序 Contact layout							
2	电缆类型 Cable type	护套颜色 Jacket color						
	导体横截面 0.34mm ²	灰 GY	黑 BK	黄 YE	灰 GY	黑 BK	灰 GY	黑 BK
	PVC	213	613		214	614	215	615
	PUR	223	623		224	624	225	625
	PUR 高柔性 Highly flexible		633		634		635	
	抗扭、防飞溅 Torsion, welding spark resistant			154 054				
	导体横截面 0.5mm ² (抗扭、防飞溅)			174				
	导体横截面 0.25mm ²						灰 GY	
	PVC						292	
	PUR						295	
3	电缆长度 Cable length							
	1.5m	0150						
	3.0m	0300						
	5.0m	0500						
	7.5m	0750						
	10.0m	1000						
	订货号 Part No.							
	可参考: 5.0.1 Reference: 5.0.1	例: <u> 912321 </u> — <u> 213 </u> — <u> 0500 </u>						
		1 型号 Form	2 电缆类型 Cable type	3 电缆长度 Cable length				
	备注 Notes	电缆参数 Cable parameter: 5.0.1 配件页面 Accessories on page: 5.2.43 不同的电缆长度可根据实际需要, 在订货号的第三部分自行修改, 电缆长度单位: cm						

M12 圆形连接器

M12 圆形连接器 ROUND PLUG CONNECTOR

单端预铸线束
With open ended wires

插孔 Female
90°



M12 圆形连接器

1 型号 Form No.	919061	927061
	食品和饮料 FOOD & BEVERAGE 919061F	927061F
极数 Suppression	12-pole	17-pole
电路图 Circuit diagram		
针脚排序 Contact layout	<p>插孔 Female</p>	<p>插孔 Female</p>
2 电缆类型 Cable type	护套颜色 Jacket color	
导体横截面 0.25mm ²	灰 GY	
PUR 高柔性 Highly flexible	301	
导体横截面 0.14mm ²	黑 BK	黑 BK
PVC	702	742
PUR 高柔性 Highly flexible	705	745
3 电缆长度 Cable length		
1.5m	0150	
3.0m	0300	
5.0m	0500	
7.5m	0750	
10.0m	1000	
技术参数 Technical data		
工作电压 Supply voltage	max. 30 V AC/DC	
防护等级 Protection	IP67- 插孔插针配合拧紧 (EN 60529) When plugged and screwed down	
温度范围 Temperature range	-25...+85°C	
订货号 Part No.		
可参考: 5.0.1 Reference: 5.0.1	例: <u> 919061 </u> - <u> 301 </u> - <u> 0500 </u>	
	1 型号 Form	2 电缆类型 Cable type
		3 电缆长度 Cable length
备注 Notes		
	电缆参数 Cable parameter: 5.0.1 配件及技术页面 Accessories and technical page: 5.2.43 不同的电缆长度可根据实际需要, 在订货号的第三部分自行修改, 电缆长度单位: cm	

M12 圆形连接器 ROUND PLUG CONNECTOR

单端预铸线束
 With open ended wires
 带 LED
 With LED

插孔 Female
 直出 Straight



插孔 Female
 90°



1	型号 Form No.	912261	912281	912381	912401						
	食品和饮料 FOOD & BEVERAGE	912261F	912281F	912381F	912401F						
	极数 Suppression	3-pole带2xLED(PNP) 3-pole with 2 x LED (PNP)	4-pole带2xLED(PNP) 4-pole with 2 x LED (PNP)	3-pole带2xLED(PNP) 3-pole with 2 x LED (PNP)	4-pole带2xLED(PNP) 4-pole with 2 x LED (PNP)						
	电路图 Circuit diagram										
	针脚排序 Contact layout										
2	电缆类型 Cable type	护套颜色 Jacket color									
	导体横截面 0.34mm ²	灰 GY	黑 BK	灰 GY	黑 BK	灰 GY	黑 BK	灰 GY	黑 BK		
	PVC	213	613	213	613	213	613	213	613		
	PUR	223	623	223	623	223	623	223	623		
	PUR 高柔性 Highly flexible		633		633		633		633		
3	电缆长度 Cable length	1.5m	0150	3.0m	0300	5.0m	0500	7.5m	0750	10.0m	1000
	订货号 Part No.	例: <u> 912261 </u> - <u> 213 </u> - <u> 0500 </u>									
	可参考: 5.0.1 Reference: 5.0.1										
	备注 Notes	1 型号 Form 2 电缆类型 Cable type 3 电缆长度 Cable length									
		电缆参数 Cable parameter: 5.0.1 配件页面 Accessories on page: 5.2.43 不同的电缆长度可根据实际需要, 在订货号的第三部分自行修改, 电缆长度单位: cm									

M12 圆形连接器

M12 圆形连接器 ROUND PLUG CONNECTOR

单端预铸线束
With open ended wires

带 LED
With LED

插孔 Female
90°



1 型号 Form No. 912421 912441

食品和饮料 FOOD & BEVERAGE	912421F	912441F
极数 Suppression	4-pole带3xLED(PNP) 4-pole with 3 x LED (PNP)	5-pole带3xLED(PNP) 5-pole with 3 x LED (PNP)

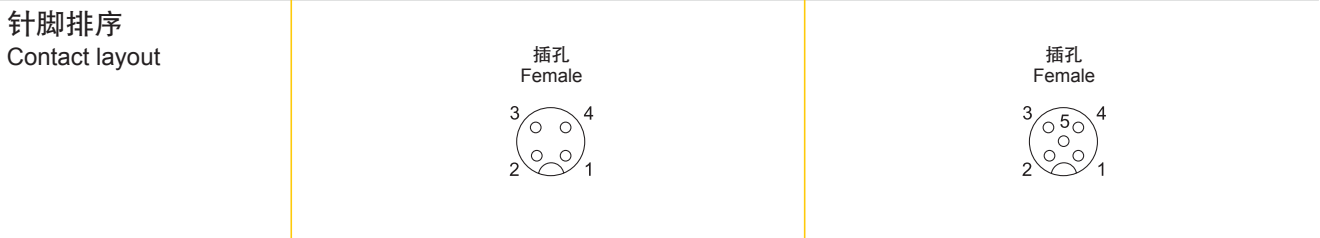
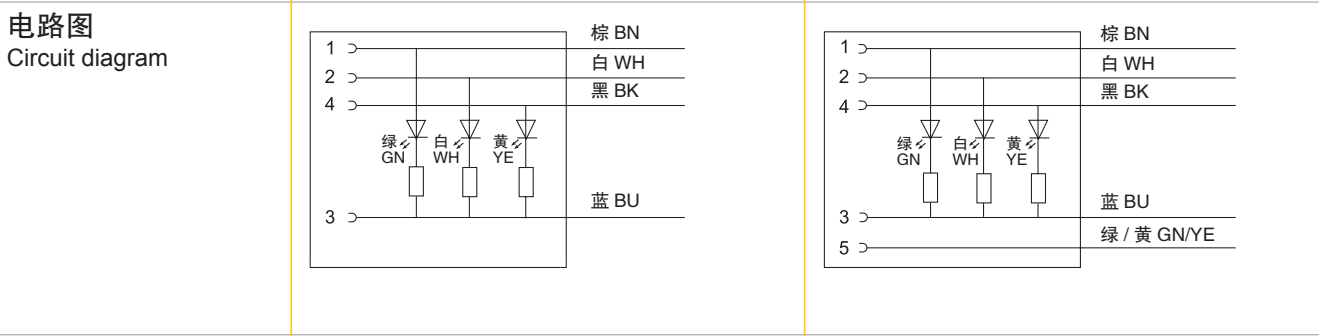

2 电缆类型 Cable type 护套颜色 Jacket color

导体横截面 0.34mm ²	黄 YE	橙 OG	灰 GY	黑 BK	灰 GY	黑 BK
PVC			214	614	215	615
PUR			224	624	225	625
PUR 高柔性 Highly flexible				634		635
抗扭、防飞溅 Torsion, welding spark resistant	154	054				

3 电缆长度 Cable length

1.5m	0150
3.0m	0300
5.0m	0500
7.5m	0750
10.0m	1000

订货号 Part No.

可参考: 5.0.1
Reference: 5.0.1

例: 912421 - 214 - 0500

1 型号 Form **2** 电缆类型 Cable type **3** 电缆长度 Cable length

备注 Notes







电缆参数 Cable parameter: 5.0.1 配件及技术页面 Accessories and technical page: 5.2.43
不同的电缆长度可根据实际需要, 在订货号的第三部分自行修改, 电缆长度单位: cm

M12 圆形连接器 ROUND PLUG CONNECTOR

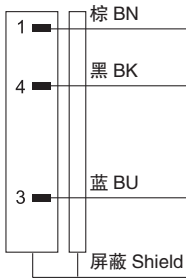
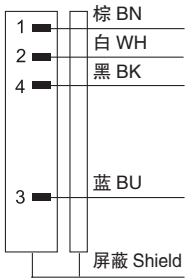
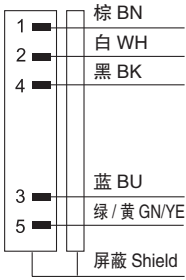
单端预铸线束
 With open ended wires
 屏蔽
 Shielded

插针 Male
 直出 Straight

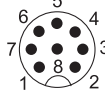
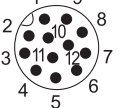

1	型号 Form No.	913061	913081	913101	917081	919301
食品和饮料 FOOD & BEVERAGE		913061F	913081F	913101F	917081F	919301F
极数 Suppression		3-pole	4-pole	5-pole	8-pole	12-pole
电路图 Circuit diagram						
针脚排序 Contact layout		插针 Male 	插针 Male 	插针 Male 	插针 Male 	插针 Male 
2	电缆类型 Cable type	护套颜色 Jacket color				
	导体横截面 0.34mm ²	灰 GY	灰 GY	灰 GY		
	PVC	317	330	348		
	PUR	318	331	349		
	导体横截面 0.25mm ²				黑 BK 灰 GY	
	PVC				294	
	PUR				297	
	导体横截面 0.14mm ²					黑 BK
	PVC					703
	PUR 高柔性 Highly flexible					706
3	电缆长度 Cable length					
	1.5m	0150				
	3.0m	0300				
	5.0m	0500				
	10.0m	1000				
	技术参数 Technical data					
	工作电压 Supply voltage	125 V AC/DC			60 V AC/DC	30 V AC/DC
	额定电流 Current per contact(40°C)	max. 4A			max. 2 A	
	防护等级 Protection	IP67- 插孔插针配合拧紧 (EN 60529) When plugged and screwed down				
	温度范围 Temperature range	-25...+85°C				
	订货号 Part No.					
	可参考: 5.0.1 Reference: 5.0.1	例: <u> 913061 </u> — <u> 317 </u> — <u> 0500 </u>				
		1 型号 Form	2 电缆类型 Cable type	3 电缆长度 Cable length		
	备注 Notes					
		电缆参数 Cable parameter: 5.0.1 配件页面 Accessories on page: 5.2.43 不同的电缆长度可根据实际需要, 在订货号的第三部分自行修改, 电缆长度单位: cm				

M12 圆形连接器 ROUND PLUG CONNECTOR

单端预铸线束
With open ended wires
屏蔽
Shielded

插针 Male
90°



1	型号 Form No.	913121	913141	913161	917101	919321	
	食品和饮料 FOOD & BEVERAGE	913121F	913141F	913161F	917101F	919321F	
	极数 Suppression	3-pole	4-pole	5-pole	8-pole	12-pole	
	电路图 Circuit diagram						
	针脚排序 Contact layout	插针 Male 	插针 Male 	插针 Male 	插针 Male 	插针 Male 	
2	电缆类型 Cable type	护套颜色 Jacket color					
	导体横截面 0.34mm ²	灰 GY	灰 GY	灰 GY			
	PVC	317	330	348			
	PUR	318	331	349			
	导体横截面 0.25mm ²				黑 BK 灰 GY		
	PVC				294		
	PUR				297		
	导体横截面 0.14mm ²					黑 BK	
	PVC					703	
	PUR 高柔性 Highly flexible					706	
3	电缆长度 Cable length	1.5m	0150				
	3.0m	0300					
	5.0m	0500					
	10.0m	1000					
	技术参数 Technical data	工作电压 Supply voltage			125 V AC/DC	60 V AC/DC	30 V AC/DC
	额定电流 Current per contact(40°C)	max. 4A			max. 2 A		
	防护等级 Protection	IP67- 插孔插针配合拧紧 (EN 60529) When plugged and screwed down					
	温度范围 Temperature range	-25...+85°C					
	订货号 Part No.	例: <u> 913121 </u> - <u> 317 </u> - <u> 0500 </u>					
	可参考: 5.0.1 Reference: 5.0.1						
		1	2	3			
		型号 Form	电缆类型 Cable type	电缆长度 Cable length			
	备注 Notes	电缆参数 Cable parameter: 5.0.1 配件及技术页面 Accessories and technical page: 5.2.43 不同的电缆长度可根据实际需要, 在订货号的第三部分自行修改, 电缆长度单位: cm					

M12 圆形连接器

M12 圆形连接器 ROUND PLUG CONNECTOR

单端预铸线束
 With open ended wires
 屏蔽
 Shielded

插孔 Female
 直出 Straight



1	型号 Form No.	913181	913201	913221	917121	919341	
食品和饮料 FOOD & BEVERAGE		913181F	913201F	913221F	917121F	919341F	
极数 Suppression		3-pole	4-pole	5-pole	8-pole	12-pole	
电路图 Circuit diagram							
针脚排序 Contact layout		插孔 Female 	插孔 Female 	插孔 Female 	插孔 Female 	插孔 Female 	
2	电缆类型 Cable type	护套颜色 Jacket color					
	导体横截面 0.34mm ²	灰 GY	灰 GY	灰 GY			
	PVC	317	330	348			
	PUR	318	331	349			
	导体横截面 0.25mm ²				黑 BK 灰 GY		
	PVC				294		
	PUR				297		
	导体横截面 0.14mm ²					黑 BK	
	PVC					703	
	PUR 高柔性 Highly flexible					706	
3	电缆长度 Cable length						
	1.5m	0150					
	3.0m	0300					
	5.0m	0500					
	10.0m	1000					
	技术参数 Technical data						
	工作电压 Supply voltage	125 V AC/DC			60 V AC/DC	30 V AC/DC	
	额定电流 Current per contact(40°C)	max. 4A			max. 2 A		
	防护等级 Protection	IP67- 插孔插针配合拧紧 (EN 60529) When plugged and screwed down					
	温度范围 Temperature range	-25...+85°C					
	订货号 Part No.						
	可参考: 5.0.1 Reference: 5.0.1	例: <u> 913181 </u> - <u> 317 </u> - <u> 0500 </u>					
		1	型号 Form	2	电缆类型 Cable type	3	电缆长度 Cable length
	备注 Notes						
		电缆参数 Cable parameter: 5.0.1 配件页面 Accessories on page: 5.2.43 不同的电缆长度可根据实际需要, 在订货号的第三部分自行修改, 电缆长度单位: cm					

M12 圆形连接器 ROUND PLUG CONNECTOR

单端预铸线束
With open ended wires
屏蔽
Shielded

插孔 Female
90°



M12 圆形连接器

1	型号 Form No.	913241	913261	913281	917141	919361	
	食品和饮料 FOOD & BEVERAGE	913241F	913261F	913281F	917141F	919361F	
	极数 Suppression	3-pole	4-pole	5-pole	8-pole	12-pole	
	电路图 Circuit diagram						
	针脚排序 Contact layout	插孔 Female 	插孔 Female 	插孔 Female 	插孔 Female 	插孔 Female 	
2	电缆类型 Cable type	护套颜色 Jacket color					
	导体横截面 0.34mm ²	灰 GY	灰 GY	灰 GY			
	PVC	317	330	348			
	PUR	318	331	349			
	导体横截面 0.25mm ²				黑 BK 灰 GY		
	PVC				294		
	PUR				297		
	导体横截面 0.14mm ²					黑 BK	
	PVC					703	
	PUR 高柔性 Highly flexible					706	
3	电缆长度 Cable length						
	1.5m	0150					
	3.0m	0300					
	5.0m	0500					
	10.0m	1000					
	技术参数 Technical data						
	工作电压 Supply voltage	125 V AC/DC			60 V AC/DC	30 V AC/DC	
	额定电流 Current per contact(40°C)	max. 4A			max. 2 A		
	防护等级 Protection	IP67- 插孔插针配合拧紧 (EN 60529) When plugged and screwed down					
	温度范围 Temperature range	-25...+85°C					
	订货号 Part No.						
	可参考: 5.0.1 Reference: 5.0.1	例: <u> 913241 </u> - <u> 317 </u> - <u> 0500 </u>					
		1	型号 Form	2	电缆类型 Cable type	3	电缆长度 Cable length
	备注 Notes						
		电缆参数 Cable parameter: 5.0.1 配件及技术页面 Accessories and technical page: 5.2.43 不同的电缆长度可根据实际需要, 在订货号的第三部分自行修改, 电缆长度单位: cm					

M12 圆形连接器 ROUND PLUG CONNECTOR

双端预铸线束
 Connection cable
 -M12-M12

插针 Male
 直出 Straight

插孔 Female
 直出 Straight

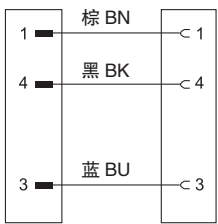
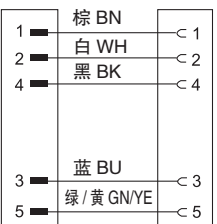
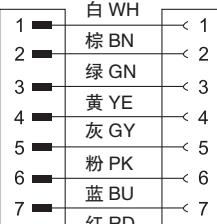
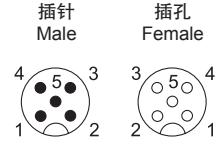
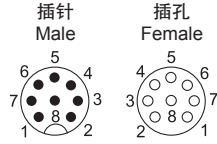

1	型号 Form No.	940001	940021	940041	948001			
食品和饮料 FOOD & BEVERAGE	940001F	940021F	940041F	948001F				
极数 Suppression	3-pole	4-pole	5-pole	8-pole				
电路图 Circuit diagram								
针脚排序 Contact layout								
2	电缆类型 Cable type	护套颜色 Jacket color						
	导体横截面 0.34mm ²	灰 GY	黑 BK	黄 YE	灰 GY	黑 BK	灰 GY	黑 BK
	PVC	213	613		214	614	215	615
	PUR	223	623		224	624	225	625
	PUR 高柔性 Highly flexible		633			634		635
	抗扭、防飞溅 Torsion, welding spark resistant			154 054				
	导体横截面 0.5mm ² (抗扭、防飞溅)			174				
	导体横截面 0.25mm ²						灰 GY	
	PVC						292	
	PUR						295	
3	电缆长度 Cable length							
	1.5m	0150						
	3.0m	0300						
	5.0m	0500						
	7.5m	0750						
	10.0m	1000						
	订货号 Part No.							
	可参考: 5.0.1 Reference: 5.0.1	例: <u> 940001 </u> - <u> 213 </u> - <u> 0500 </u>						
		1	型号 Form	2	电缆类型 Cable type	3	电缆长度 Cable length	
备注 Notes	电缆参数 Cable parameter: 5.0.1 配件页面 Accessories on page: 5.2.43 不同的电缆长度可根据实际需要, 在订货号的第三部分自行修改, 电缆长度单位: cm							

M12 圆形连接器 ROUND PLUG CONNECTOR

双端预铸线束
Connection cable
-M12-M12

插针 Male
直出 Straight

插孔 Female
90°



M12 圆形连接器

1	型号 Form No.	940101	940121	940141				
	食品和饮料 FOOD & BEVERAGE	940101F	940121F	940141F				
	极数 Suppression	3-pole	4-pole	5-pole				
	电路图 Circuit diagram							
	针脚排序 Contact layout							
2	电缆类型 Cable type	护套颜色 Jacket color						
	导体横截面 0.34mm ²	灰 GY	黑 BK	黄 YE	灰 GY	黑 BK	灰 GY	黑 BK
	PVC	213	613		214	614	215	615
	PUR	223	623		224	624	225	625
	PUR 高柔性 Highly flexible		633			634		635
	抗扭、防飞溅 Torsion, welding spark resistant			154 054				
	导体横截面 0.5mm ² (抗扭、防飞溅)			174				
3	电缆长度 Cable length							
	0.3m	0030						
	0.6m	0060						
	1.0m	0100						
	1.5m	0150						
	2.0m	0200						
	订货号 Part No.							
	可参考: 5.0.1 Reference: 5.0.1	例: <u> 940101 </u> - <u> 213 </u> - <u> 0500 </u>						
		1	型号 Form	2	电缆类型 Cable type	3	电缆长度 Cable length	
	备注 Notes							
		电缆参数 Cable parameter: 5.0.1 配件及技术页面 Accessories and technical page: 5.2.43 不同的电缆长度可根据实际需要, 在订货号的第三部分自行修改, 电缆长度单位: cm						

M12 圆形连接器 ROUND PLUG CONNECTOR

双端预铸线束
 Connection cable
 -M12-M12

插针 Male
 90°

插孔 Female
 直出 Straight



1	型号 Form No.	940171	940201	940221				
食品和饮料 FOOD & BEVERAGE	940171F	940201F	940221F					
极数 Suppression	3-pole	4-pole	5-pole					
电路图 Circuit diagram								
针脚排序 Contact layout								
2	电缆类型 Cable type	护套颜色 Jacket color						
导体横截面 0.34mm ²		灰 GY	黑 BK	黄 YE	灰 GY	黑 BK	灰 GY	黑 BK
PVC		213	613		214	614	215	615
PUR		223	623		224	624	225	625
PUR 高柔性 Highly flexible			633			634		635
抗扭、防飞溅 Torsion, welding spark resistant				154 054				
导体横截面 0.5mm ² (抗扭、防飞溅)				174				
3	电缆长度 Cable length							
0.3m	0030							
0.6m	0060							
1.0m	0100							
1.5m	0150							
2.0m	0200							
订货号 Part No.								
可参考: 5.0.1 Reference: 5.0.1	例:	940171	213	0500				
	1	型号 Form	2	电缆类型 Cable type	3	电缆长度 Cable length		
备注 Notes	电缆参数 Cable parameter: 5.0.1 配件页面 Accessories on page: 5.2.43 不同的电缆长度可根据实际需要, 在订货号的第三部分自行修改, 电缆长度单位: cm							

M12 圆形连接器 ROUND PLUG CONNECTOR

双端预铸线束
Connection cable
-M12-M12

插针 Male
90°

插孔 Female
90°



M12 圆形连接器

1	型号 Form No.	940172	940202	940222				
	食品和饮料 FOOD & BEVERAGE	940172F	940202F	940222F				
	极数 Suppression	3-pole	4-pole	5-pole				
	电路图 Circuit diagram							
	针脚排序 Contact layout							
2	电缆类型 Cable type	护套颜色 Jacket color						
	导体横截面 0.34mm ²	灰 GY	黑 BK	黄 YE	灰 GY	黑 BK	灰 GY	黑 BK
	PVC	213	613		214	614	215	615
	PUR	223	623		224	624	225	625
	PUR 高柔性 Highly flexible		633			634		635
	抗扭、防飞溅 Torsion, welding spark resistant			154 054				
	导体横截面 0.5mm ² (抗扭、防飞溅)			174				
3	电缆长度 Cable length							
	0.3m	0030						
	0.6m	0060						
	1.0m	0100						
	1.5m	0150						
	2.0m	0200						
	订货号 Part No.							
	可参考: 5.0.1 Reference: 5.0.1	例: 940172		213		0500		
		1	型号 Form	2	电缆类型 Cable type	3	电缆长度 Cable length	
	备注 Notes							
		电缆参数 Cable parameter: 5.0.1 配件及技术页面 Accessories and technical page: 5.2.43 不同的电缆长度可根据实际需要, 在订货号的第三部分自行修改, 电缆长度单位: cm						

M12 圆形连接器 ROUND PLUG CONNECTOR

双端预铸线束
Connection cable
-M12-M8

插针 Male
直出 Straight

插孔 Female
直出 Straight

插针 Male
直出 Straight

插孔 Female
90°



1	型号 Form No.	940561	940581	940601	940621							
食品和饮料 FOOD & BEVERAGE	940561F	940581F	940601F	940621F								
极数 Suppression	3-pole	4-pole	3-pole	4-pole								
电路图 Circuit diagram												
针脚排序 Contact layout												
2	电缆类型 Cable type	护套颜色 Jacket color										
导体横截面 0.25mm ²	黄 YE	灰 GY	黑 BK	黄 YE	灰 GY	黑 BK	黄 YE	灰 GY	黑 BK	黄 YE	灰 GY	黑 BK
PVC		210	610		211	611		210	610		211	611
PUR		220	620		221	621		220	620		221	621
PUR 高柔性 Highly flexible			630			631			630			631
抗扭、防飞溅 Torsion, welding spark resistant	150	050	650	151	051		150	050	650	151	051	
3	电缆长度 Cable length											
0.3m	0030											
0.6m	0060											
1.0m	0100											
1.5m	0150											
2.0m	0200											
订货号 Part No.												
可参考: 5.0.1 Reference: 5.0.1	例: <u> 940561 </u> - <u> 210 </u> - <u> 0500 </u>											
	1	型号 Form	2	电缆类型 Cable type	3	电缆长度 Cable length						
备注 Notes	电缆参数 Cable parameter: 5.0.1 配件页面 Accessories on page: 5.2.43 不同的电缆长度可根据实际需要, 在订货号的第三部分自行修改, 电缆长度单位: cm											

M12 圆形连接器

M12 圆形连接器 ROUND PLUG CONNECTOR

双端预铸线束
Connection cable
-M12-M8

插针 Male
直出 Straight

插孔 Female
90° with 带 LED



1 型号 Form No. 940641

食品和饮料 FOOD & BEVERAGE	940641F
极数 Suppression	3-pole带2xLED(PNP) 3-pole with 2 x LED (PNP)

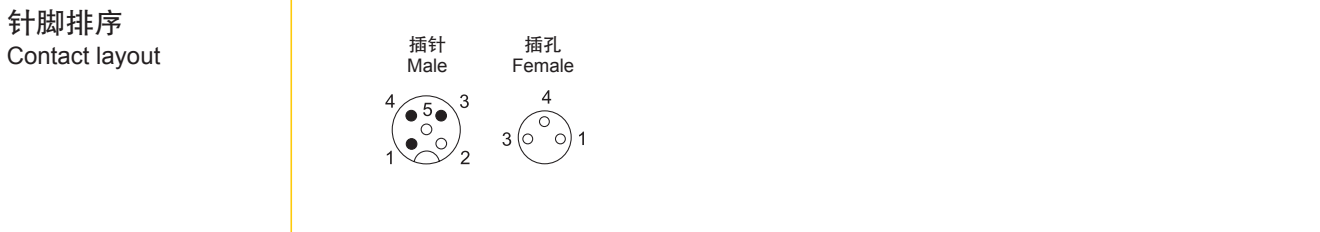
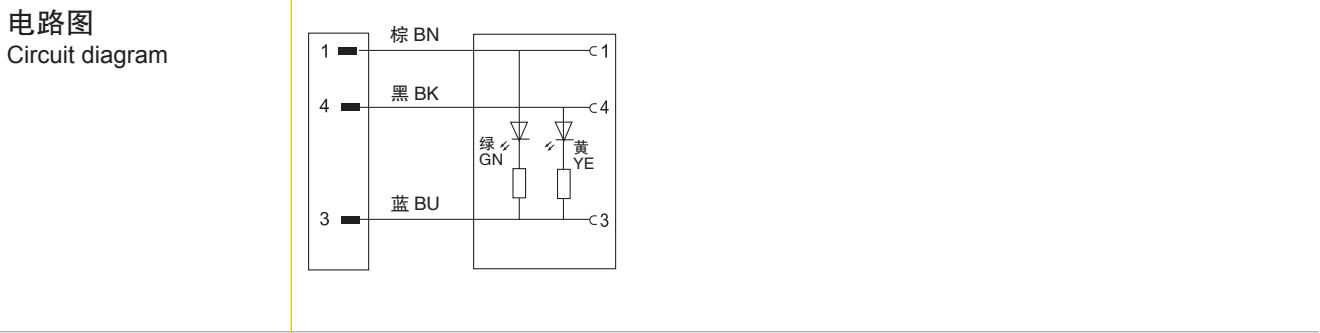

2 电缆类型 Cable type 护套颜色 Jacket color

导体横截面 0.25mm ²	黄 YE	橙 OG	灰 GY	黑 BK
PVC			210	610
PUR			220	620
PUR 高柔性 Highly flexible				630
抗扭、防飞溅 Torsion, welding spark resistant	150	050		650

3 电缆长度 Cable length

0.3m	0030
0.6m	0060
1.0m	0100
1.5m	0150
2.0m	0200

订货号 Part No.

可参考: 5.0.1
Reference: 5.0.1

例: 940641 - 210 - 0500

1 型号 Form **2** 电缆类型 Cable type **3** 电缆长度 Cable length

备注 Notes

电缆参数 Cable parameter: 5.0.1 配件及技术页面 Accessories and technical page: 5.2.43
不同的电缆长度可根据实际需要, 在订货号的第三部分自行修改, 电缆长度单位: cm

M12 圆形连接器 ROUND PLUG CONNECTOR

双端预铸线束
 Connection cable
 -M12-M12

插针 Male
 直出 Straight

插孔 Female
 90° with 带 LED



1	型号 Form No.	940321	940341	940361				
食品和饮料 FOOD & BEVERAGE		940321F	940341F	940361F				
极数 Suppression		3-pole 带2xLED (PNP) 3-pole with 2 x LED (PNP)	4-pole 带3xLED (PNP) 4-pole with 3 x LED (PNP)	5-pole 带3xLED (PNP) 5-pole with 3 x LED (PNP)				
电路图 Circuit diagram								
针脚排序 Contact layout								
2	电缆类型 Cable type	护套颜色 Jacket color						
	导体横截面 0.34mm ²	灰 GY	黑 BK	黄 YE	灰 GY	黑 BK	灰 GY	黑 BK
	PVC	213	613		214	614	215	615
	PUR	223	623		224	624	225	625
	PUR 高柔性 Highly flexible		633			634		635
	抗扭、防飞溅 Torsion, welding spark resistant			154 054				
3	电缆长度 Cable length							
	0.3m	0030						
	0.6m	0060						
	1.0m	0100						
	1.5m	0150						
	2.0m	0200						
	订货号 Part No.							
	可参考: 5.0.1 Reference: 5.0.1	例: <u> 940321 </u> — <u> 213 </u> — <u> 0500 </u>						
		1	型号 Form	2	电缆类型 Cable type	3	电缆长度 Cable length	
备注 Notes	电缆参数 Cable parameter: 5.0.1 配件页面 Accessories on page: 5.2.43 不同的电缆长度可根据实际需要, 在订货号的第三部分自行修改, 电缆长度单位: cm							

M12 圆形连接器 ROUND PLUG CONNECTOR

双端预铸线束
Connection cable
-M12-M12

插针 Male
直出 Straight

插孔 Female
90° with 带 LED



1 型号 Form No. 940381

食品和饮料 FOOD & BEVERAGE	940381F
极数	3-pole 带2xLED (PNP)
Suppression	3-pole with 2 x LED (PNP)

电路图
Circuit diagram

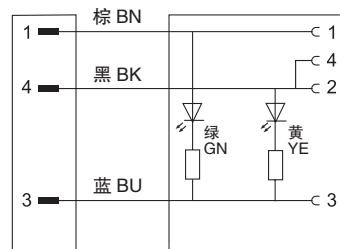

针脚排序
Contact layout

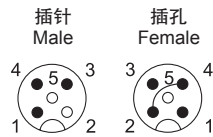

2 电缆类型 Cable type 护套颜色 Jacket color

导体横截面 0.34mm ²	黄 YE	橙 OG	灰 GY	黑 BK
PVC			213	613
PUR			223	623
PUR 高柔性 Highly flexible				633
抗扭、防飞溅 Torsion, welding spark resistant	153	053		

3 电缆长度 Cable length

0.3m	0030
0.6m	0060
1.0m	0100
1.5m	0150
2.0m	0200

订货号 Part No.

可参考: 5.0.1
Reference: 5.0.1

例: 940381 - 213 - 0500

1 型号 Form **2** 电缆类型 Cable type **3** 电缆长度 Cable length

备注 Notes

电缆参数 Cable parameter: 5.0.1 配件及技术页面 Accessories and technical page: 5.2.43
不同的电缆长度可根据实际需要, 在订货号的第三部分自行修改, 电缆长度单位: cm

M12 圆形连接器 ROUND PLUG CONNECTOR

双端预铸线束
 Connection cable

插针 Male
 直出 Straight

插孔 Female
 直出 Straight

-M12-M12

屏蔽
 Shielded



1	型号 Form No.	940481	940501	940521	948041
食品和饮料 FOOD & BEVERAGE	940481F	940501F	940521F	948041F	
极数 Suppression	3-pole	4-pole	5-pole	8-pole	
电路图 Circuit diagram					
针脚排序 Contact layout					
2	电缆类型 Cable type	护套颜色 Jacket color			
	导体横截面 0.34mm ²	灰 GY	灰 GY	灰 GY	
	PVC	317	330	348	
	PUR	318	331	349	
	导体横截面 0.25mm ²				黑 BK 灰 GY
	PVC				294
	PUR				297
3	电缆长度 Cable length				
	0.3m	0030			
	0.6m	0060			
	1.0m	0100			
	1.5m	0150			
	2.0m	0200			
	订货号 Part No.				
	可参考: 5.0.1 Reference: 5.0.1	例: <u> 940481 </u> — <u> 317 </u> — <u> 0500 </u>			
		1 型号 Form	2 电缆类型 Cable type	3 电缆长度 Cable length	
备注 Notes	电缆参数 Cable parameter: 5.0.1 配件页面 Accessories on page: 5.2.43 不同的电缆长度可根据实际需要, 在订货号的第三部分自行修改, 电缆长度单位: cm				

M12 圆形连接器

M12 圆形连接器 ROUND PLUG CONNECTOR

双端预铸线束
Connection cable

-M12-M12

屏蔽
Shielded

插针 Male
直出 Straight

插孔 Female
90°



M12 圆形连接器

1	型号 Form No.	944121	944131	944141	948181
	食品和饮料 FOOD & BEVERAGE	944121F	944131F	944141F	948181F
	极数 Suppression	3-pole	4-pole	5-pole	8-pole
	电路图 Circuit diagram				
	针脚排序 Contact layout				
2	电缆类型 Cable type	护套颜色 Jacket color			
	导体横截面 0.34mm ²	灰 GY	灰 GY	灰 GY	
	PVC	317	330	348	
	PUR	318	331	349	
	导体横截面 0.25mm ²				黑 BK 灰 GY
	PVC				294
	PUR				297
3	电缆长度 Cable length				
	0.3m	0030			
	0.6m	0060			
	1.0m	0100			
	1.5m	0150			
	2.0m	0200			
	订货号 Part No.				
	可参考: 5.0.1 Reference: 5.0.1	例: <u> 944121 </u> - <u> 317 </u> - <u> 0500 </u>			
		1 型号 Form	2 电缆类型 Cable type	3 电缆长度 Cable length	
	备注 Notes	电缆参数 Cable parameter: 5.0.1 配件及技术页面 Accessories and technical page: 5.2.43 不同的电缆长度可根据实际需要, 在订货号的第三部分自行修改, 电缆长度单位: cm			

M12 圆形连接器 ROUND PLUG CONNECTOR

单端预铸线束
With open ended wires
-M12-2 自由端
- The free end M12-2

插针 Male
Y 形直出 Distributor
自由端 The free end



1	型号 Form No.	940941	940901				
	食品和饮料 FOOD & BEVERAGE	940941F	940901F				
	极数 Suppression	3-pole	4-pole				
	电路图 Circuit diagram						
	针脚排序 Contact layout	<p>Y- 插针 Y-Male</p>	<p>Y- 插针 Y-Male</p>				
2	电缆类型 Cable type	护套颜色 Jacket color					
	导体横截面 0.34mm ²	灰 GY	黑 BK	黄 YE	橙 OG	灰 GY	黑 BK
	PVC	213	613			214	614
	PUR	223	623			224	624
	PUR 高柔性 Highly flexible		633				634
	抗扭、防飞溅 Torsion, welding spark resistant			154	054		
3	电缆长度 Cable length						
	0.3m	0030					
	0.6m	0060					
	1.0m	0100					
	1.5m	0150					
	2.0m	0200					
	订货号 Part No.						
	可参考: 5.0.1 Reference: 5.0.1	例: <u> 940941 </u> - <u> 213 </u> - <u> 0500 </u>					
		1 型号 Form	2 电缆类型 Cable type	3 电缆长度 Cable length			
	备注 Notes	电缆参数 Cable parameter: 5.0.1 配件页面 Accessories on page: 5.2.43 不同的电缆长度可根据实际需要, 在订货号的第三部分自行修改, 电缆长度单位: cm					

M12 圆形连接器 ROUND PLUG CONNECTOR

双端预铸线束
Connection cable

-M12-2M12

插针 Male
Y形直出 Distributor

插孔 Female
直出 Straight



M12 圆形连接器

1	型号 Form No.	940701	940721				
	食品和饮料 FOOD & BEVERAGE	940701F	940721F				
	极数 Suppression	3-pole	4-pole				
	电路图 Circuit diagram						
	针脚排序 Contact layout						
2	电缆类型 Cable type	护套颜色 Jacket color					
	导体横截面 0.34mm ²	灰 GY	黑 BK	黄 YE	橙 OG	灰 GY	黑 BK
	PVC	213	613			214	614
	PUR	223	623			224	624
	PUR 高柔性 Highly flexible		633				634
	抗扭、防飞溅 Torsion, welding spark resistant			154	054		
3	电缆长度 Cable length						
	0.3m	0030					
	0.6m	0060					
	1.0m	0100					
	1.5m	0150					
	2.0m	0200					
	订货号 Part No.						
	可参考: 5.0.1 Reference: 5.0.1	例: <u> 940701 </u> - <u> 213 </u> - <u> 0500 </u>					
		1	型号 Form	2	电缆类型 Cable type	3	电缆长度 Cable length
	备注 Notes	电缆参数 Cable parameter: 5.0.1 配件及技术页面 Accessories and technical page: 5.2.43 不同的电缆长度可根据实际需要, 在订货号的第三部分自行修改, 电缆长度单位: cm					

M12 圆形连接器 ROUND PLUG CONNECTOR

双端预铸线束
Connection cable
-M12-2M12

插针 Male
Y 形直出 Distributor

插孔 Female
90°



1	型号 Form No.	940741	940761				
	食品和饮料 FOOD & BEVERAGE	940741F	940761F				
	极数 Suppression	3-pole	4-pole				
	电路图 Circuit diagram						
	针脚排序 Contact layout						
	2	电缆类型 Cable type	护套颜色 Jacket color				
	导体横截面 0.34mm ²	灰 GY	黑 BK	黄 YE	橙 OG	灰 GY	黑 BK
	PVC	213	613			214	614
	PUR	223	623			224	624
	PUR 高柔性 Highly flexible		633				634
	抗扭、防飞溅 Torsion, welding spark resistant			154	054		
3	3	电缆长度 Cable length					
		0.3m	0030				
		0.6m	0060				
		1.0m	0100				
		1.5m	0150				
		2.0m	0200				
	订货号 Part No.						
	可参考: 5.0.1 Reference: 5.0.1	例: 940741	213	0500			
	1	型号 Form	2	电缆类型 Cable type	3	电缆长度 Cable length	
备注 Notes	电缆参数 Cable parameter: 5.0.1 配件页面 Accessories on page: 5.2.43 不同的电缆长度可根据实际需要, 在订货号的第三部分自行修改, 电缆长度单位: cm						

M12 圆形连接器 ROUND PLUG CONNECTOR

双端预铸线束
Connection cable

-M12-2M12
-M12-2M8

插针 Male
Y形直出 Distributor

插孔 Female
90° with LED

插针 Male
Y形直出
Distributor

插孔 Female
90°



1	型号 Form No.	940781	940801	940861						
	食品和饮料 FOOD & BEVERAGE	940781F	940801F	940861F						
	极数 Suppression	3-pole带2xLED(PNP) 3-pole with 2 x LED (PNP)	4-pole带2xLED(PNP) 4-pole with 2 x LED (PNP)	3-pole带2xLED(PNP) 3-pole with 2 x LED (PNP)						
	电路图 Circuit diagram									
	针脚排序 Contact layout									
2	电缆类型 Cable type	护套颜色 Jacket color 芯线直径 Wire 0.34mm ²		芯线直径 Wire 0.25mm ²						
	导体横截面 0.34mm ²	灰 GY	黑 BK	黄 YE	灰 GY	黑 BK	黄 YE	灰 GY	黑 BK	
	PVC	213	613		214	614		210	610	
	PUR	223	623		224	624		220	620	
	PUR 高柔性 Highly flexible		633			634			630	
	抗扭、防飞溅 Torsion, welding spark resistant			154 054			150 050			
3	电缆长度 Cable length									
	0.3m	0030								
	0.6m	0060								
	1.0m	0100								
	1.5m	0150								
	2.0m	0200								
	订货号 Part No.									
	可参考: 5.0.1 Reference: 5.0.1	例: 940781		— 213		— 0500				
		1	型号 Form	2	电缆类型 Cable type	3	电缆长度 Cable length			
	备注 Notes									
		电缆参数 Cable parameter: 5.0.1 配件及技术页面 Accessories and technical page: 5.2.43 不同的电缆长度可根据实际需要, 在订货号的第三部分自行修改, 电缆长度单位: cm								

M12 圆形连接器

M12 圆形连接器 ROUND PLUG CONNECTOR

双端预铸线束
 Connection cable
 -M12-2M8

插针 Male
 Y形直出 Distributor

插孔 Female
 直出 Straight

插针 Male
 Y形直出 Distributor

插孔 Female
 90°



1	型号 Form No.	940821			940841		
	食品和饮料 FOOD & BEVERAGE	940821F			940841F		
	极数 Suppression	3-pole			3-pole		
	电路图 Circuit diagram						
	针脚排序 Contact layout						
2	电缆类型 Cable type	护套颜色 Jacket color					
	导体横截面 0.25mm ²	黄 YE	灰 GY	黑 BK	黄 YE	灰 GY	黑 BK
	PVC		210	610		210	610
	PUR		220	620		220	620
	PUR 高柔性 Highly flexible			630			630
抗扭、防飞溅 Torsion, welding spark resistant	150	050		150	050		
3	电缆长度 Cable length						
	0.3m	0030					
	0.6m	0060					
	1.0m	0100					
	1.5m	0150					
	2.0m	0200					
	订货号 Part No.						
	可参考: 5.0.1 Reference: 5.0.1	例: <u> 940821 </u> - <u> 210 </u> - <u> 0500 </u>					
		1 型号 Form		2 电缆类型 Cable type		3 电缆长度 Cable length	
	备注 Notes						
		电缆参数 Cable parameter: 5.0.1 配件页面 Accessories on page: 5.2.43 不同的电缆长度可根据实际需要, 在订货号的第三部分自行修改, 电缆长度单位: cm					

板后安装连接器 PLATE CONNECTOR AFTER INSTALLATION

A-Coded
B-Coded
D-Coded

带线板后安装
Pre-wired installation

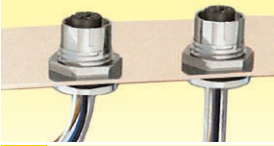

M12 插针 Male



M12 插孔 Female



1 极数 Suppression	4-pole	5-pole	8-pole	4-pole	5-pole	8-pole
电子线灌胶型订货号 Part No.	913501	913521	917161	913541	913561	917181
A-Coded 针脚排序 Contact layout	插针 Male 	插针 Male 	插针 Male 	插孔 Female 	插孔 Female 	插孔 Female
电子线灌胶型订货号 Part No.	913502	913522		913542	913562	
B-Coded 针脚排序 Contact layout	插针 Male 	插针 Male 		插孔 Female 	插孔 Female 	
电子线灌胶型订货号 Part No.	913503			913543		
D-Coded 针脚排序 Contact layout	插针 Male 			插孔 Female 		

2 螺母固定 Suitable mounting nut 默认为 M16 螺母: 971 (M16), 量大可选: 974(M12), 977(PG9), 制作带 T 料号需有对应规格书。

尺寸图 Description

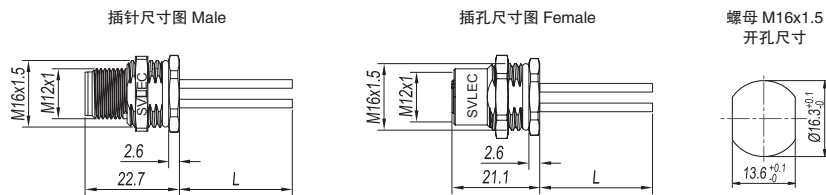

订货号 Part No.

PCB 安装产品订购
只需填写型号
PCB product installation order
only need to fill in the model

例: 913501 — 971 — 0050

1 型号 Form 2 螺母类型 Nut type 3 电缆长度 Cable length

备注 / Notes

电缆参数 Cable parameter: 5.0.1

配件页面 Accessories on page: 5.2.43

板后安装连接器 PLATE CONNECTOR AFTER INSTALLATION

带线板后安装技术参数
Pre-wired installation

A-Coded
B-Coded
D-Coded

M12 插针 Male



M12 插孔 Female



1	极数 Suppression	4-pole	5-pole	8-pole	4-pole	5-pole	8-pole
	电路图 Circuit diagram						
2	技术参数 Technical data						
A-Coded							
额定电压 Supply voltage	250 V AC/DC	125 V AC/DC	60 V AC/DC	250 V AC/DC	125 V AC/DC	60 V AC/DC	
额定电流 Current per contact (40°C)	4A		2A		4A		2A
防护等级 Protection	IP67- 插孔插针配合拧紧 (EN 60529) When plugged and screwed down						
导体截面积 Connection diameter	0.25 mm ²						
温度范围 Temperature range	- 25...+ 85 °C						
B-Coded							
额定电压 Supply voltage	250 V AC/DC	125 V AC/DC		250 V AC/DC	125 V AC/DC		
额定电流 Current per contact (40°C)	4A						
防护等级 Protection	IP67- 插孔插针配合拧紧 (EN 60529) When plugged and screwed down						
导体截面积 Connection diameter	0.25 mm ²						
温度范围 Temperature range	- 25...+ 85 °C						
D-Coded							
额定电压 Supply voltage	250 V AC/DC						
额定电流 Current per contact (40°C)	4A						
防护等级 Protection	IP67- 插孔插针配合拧紧 (EN 60529) When plugged and screwed down						
导体截面积 Connection diameter	0.25 mm ²						
温度范围 Temperature range	- 25...+ 85 °C						

板前安装连接器 BEFORE INSTALL THE CONNECTOR

A-Coded
B-Coded
D-Coded

带线板前安装
Pre-wired installation



M12 插针 Male



M12 插孔 Female



1	极数 Suppression	4-pole	5-pole	8-pole	4-pole	5-pole	8-pole
	电子线灌胶型订货号 Part No.	913504	913524	917164	913544	913564	917184
	A-Coded 针脚排序 Contact layout	插针 Male 	插针 Male 	插针 Male 	插孔 Female 	插孔 Female 	插孔 Female
	电子线灌胶型订货号 Part No.	913505	913525		913545	913565	
	B-Coded 针脚排序 Contact layout	插针 Male 	插针 Male 		插孔 Female 	插孔 Female 	
	电子线灌胶型订货号 Part No.	913506			913546		
	D-Coded 针脚排序 Contact layout	插针 Male 			插孔 Female 		

2 螺母固定 Suitable mounting nut 默认为 M16 螺母: 971 (M16), 量大可选: 974(M12), 977(PG9), 979(M20), 制作带 T 料号需有对应规格书。

尺寸图 Description

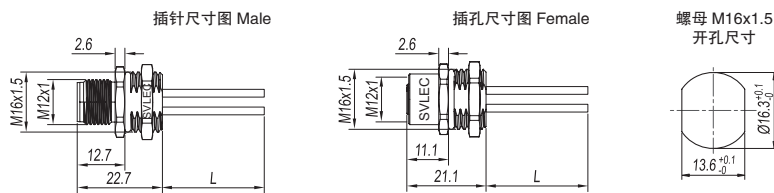

订货号 Part No.

PCB 安装产品订购
只需填写型号
PCB product installation order
only need to fill in the model

例: 913504 971 0050

1 型号 Form 2 螺母类型 Nut type 3 电缆长度 Cable length

备注 Notes

不同的电缆长度可根据实际需要, 在订货号的第三部分自行修改, 电缆长度单位: cm 电缆类型没有标注的默认为不带线的焊线结构。

板前安装连接器 PLATE CONNECTOR AFTER INSTALLATION

带线板前安装技术参数
Pre-wired installation

A-Coded
B-Coded
D-Coded

M12 插针 Male



M12 插孔 Female



1	极数 Suppression	4-pole	5-pole	8-pole	4-pole	5-pole	8-pole
	电路图 Circuit diagram						
2	技术参数 Technical data						
A-Coded							
额定电压 Supply voltage	250 V AC/DC	125 V AC/DC	60 V AC/DC	250 V AC/DC	125 V AC/DC	60 V AC/DC	
额定电流 Current per contact (40°C)	4A		2A	4A			2A
防护等级 Protection	IP67- 插孔插针配合拧紧 (EN 60529) When plugged and screwed down						
导体截面积 Connection diameter	0.25 mm ²						
温度范围 Temperature range	- 25...+ 85 °C						
B-Coded							
额定电压 Supply voltage	250 V AC/DC	125 V AC/DC		250 V AC/DC	125 V AC/DC		
额定电流 Current per contact (40°C)	4A						
防护等级 Protection	IP67- 插孔插针配合拧紧 (EN 60529) When plugged and screwed down						
导体截面积 Connection diameter	0.25 mm ²						
温度范围 Temperature range	- 25...+ 85 °C						
D-Coded							
额定电压 Supply voltage	250 V AC/DC						
额定电流 Current per contact (40°C)	4A						
防护等级 Protection	IP67- 插孔插针配合拧紧 (EN 60529) When plugged and screwed down						
导体截面积 Connection diameter	0.25 mm ²						
温度范围 Temperature range	- 25...+ 85 °C						

焊接型连接器 CONNECTOR

A-Coded
B-Coded
D-Coded



M12 插针 Male



M12 插孔 Female



1 极数 Suppression	4-pole	5-pole	8-pole	4-pole	5-pole	8-pole
PCB 焊接型订货号 Part No.	913501P	913521P	917161P	913541P	913561P	917181P
现场接线焊接型订货号 Part No.	913501S	913521S	917161S	913541S	913561S	917181S
A-Coded 针脚排序 Contact layout	插针 Male 	插针 Male 	插针 Male 	插孔 Female 	插孔 Female 	插孔 Female
PCB 焊接型订货号 Part No.	913502P	913522P		913542P	913562P	
现场接线焊接型订货号 Part No.	913502S	913522S		913542S	913562S	
B-Coded 针脚排序 Contact layout	插针 Male 	插针 Male 		插孔 Female 	插孔 Female 	
PCB 焊接型订货号 Part No.	913503P			913543P		
现场接线焊接型订货号 Part No.	913503S			913543S		
D-Coded 针脚排序 Contact layout	插针 Male 			插孔 Female 		

2 螺母固定 Suitable mounting nut 默认为 M16 螺母: 971 (M16), 量大可选: 974(M12), 974(PG9), 制作带 T 料号需有对应规格书。

尺寸图 Description

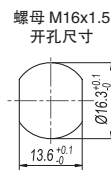
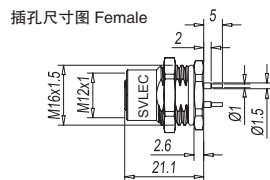
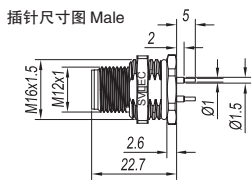

订货号 Part No.

1 型号 Form

2 螺母固定 Cable type

备注 Notes

不同的电缆长度可根据实际需要, 在订货号的第三部分自行修改, 电缆长度单位: cm 电缆类型没有标注的默认为不带线的焊线结构。

板前安装连接器 CONNECTOR







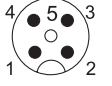

A-Coded
B-Coded
D-Coded

M12 插针 Male

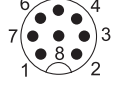

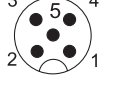
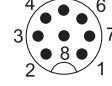
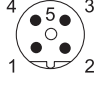
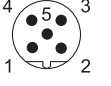
M12 插孔 Female

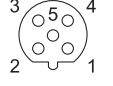

1	极数 Suppression	4-pole	5-pole	8-pole	4-pole	5-pole	8-pole
	现场接线焊接型订货号 Part No.	913504S	913524S	917164S	913544S	913564S	917184S
A-Coded 针脚排序 Contact layout	插针 Male 	插针 Male 	插针 Male 	插孔 Female 	插孔 Female 	插孔 Female 	
现场接线焊接型订货号 Part No.	913505S	913525S		913545S	913565S		
B-Coded 针脚排序 Contact layout	插针 Male 	插针 Male 		插孔 Female 	插孔 Female 		
现场接线焊接型订货号 Part No.	913506S			913546S			
D-Coded 针脚排序 Contact layout	插针 Male 			插孔 Female 			
2	螺母固定 Suitable mounting nut	默认为 M16 螺母: 971 (M16), 量大可选: 974(M12), 974(PG9), 制作带 T 料号需有对应规格书。					
	尺寸图 Description						
	订货号 Part No.	<div style="display: flex; justify-content: space-around; align-items: center;"> <div style="border-bottom: 1px dashed black; width: 150px; height: 20px;"></div> <div style="border-bottom: 1px dashed black; width: 20px; height: 20px;"></div> <div style="border-bottom: 1px dashed black; width: 150px; height: 20px;"></div> <div style="border-bottom: 1px dashed black; width: 20px; height: 20px;"></div> <div style="border-bottom: 1px dashed black; width: 150px; height: 20px;"></div> </div>					
		1 型号 Form	2 螺母固定 Cable type				
	备注 Notes	不同的电缆长度可根据实际需要, 在订货号的第三部分自行修改, 电缆长度单位: cm 电缆类型没有标注的默认为不带线的焊线结构。					

PCB 安装连接器 INSTALL THE CONNECTOR FOR

A-Coded
 B-Coded
 D-Coded
 90°

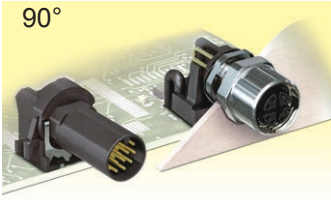









M12 插针 Male



M12 插孔 Female

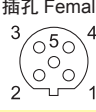
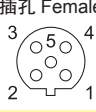

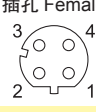
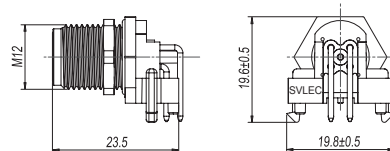
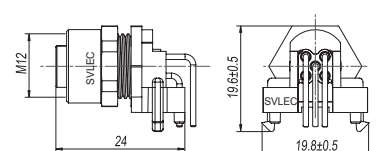
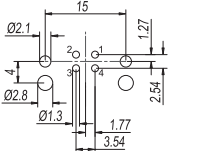
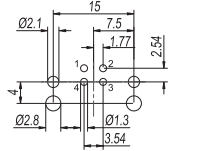
1	极数 Suppression	4-pole	5-pole	4-pole	5-pole
A-Coded 订货号 Part No.		912501	912551	912521	912581
针脚排序 Contact layout		插针 Male 	插针 Male 	插孔 Female 	插孔 Female 
B-Coded 订货号 Part No.		912541	912511	912561	912531
针脚排序 Contact layout		插针 Male 	插针 Male 	插孔 Female 	插孔 Female 
技术参数 Technical data					
额定电压 Supply voltage		250 V AC/DC	125 V AC/DC	250 V AC/DC	125 V AC/DC
额定电流 Current per contact (40°C)		4A			
防护等级 Protection		IP67-插孔插针配合拧紧(EN 60529) When plugged and screwed down			
拔插寿命(次) Pull out plug life (time)		≥ 100			
温度范围 Temperature range		-25...+85°C			
D-Coded 订货号 Part No.		912571		912591	
针脚排序 Contact layout		插针 Male 		插孔 Female 	
技术参数 Technical data					
额定电压 Supply voltage		250 V AC/DC			
额定电流 Current per contact (40°C)		4A			
防护等级 Protection		IP67-插孔插针配合拧紧(EN 60529) When plugged and screwed down			
拔插寿命(次) Pull out plug life (time)		≥ 100			
温度范围 Temperature range		-25...+85°C			
尺寸图 Description					
					
		 <p>印刷线路板厚度: 1.6MM</p>		 <p>印刷线路板厚度: 1.6MM</p>	
		M12板面弯角安装开孔尺寸		M12板面弯角安装开孔尺寸	
备注 Notes					

M12 圆形连接器

板面安装连接器 PANEL INSTALLED CONNECTORS

面板引入连接器
Control cabinet entry system

M12 插针 / 插孔 Male /Female



M12 圆形连接器

1	型号 Form No.	942111	944111	949111	948111
极数 Suppression		5-pole	5-pole, B-coded	4-pole, D-coded	8-pole
电路图 Circuit diagram					
针脚排序 Contact layout					
2	技术参数 Technical data	<p>额定电压 Supply voltage 125 V AC/DC</p> <p>额定电流 Current per contact (40°C) 4A</p> <p>防护等级 Protection IP67-插孔插针配合拧紧(EN 60529) When plugged and screwed down</p> <p>温度范围 Temperature range -25...+85°C</p>			
	尺寸图 Description				
	订货号 Part No.	<p>----- ----- ----- -----</p>			
	1 型号 Form				
	备注 Notes				

附件 ACCESSORIES

电缆标识附件 Labeling accessories		订货号 Part No.	适用范围 Suitable for
	M8 母头塑料保护盖 Plastic screw plug	996060	
	M12 公头塑料保护盖 Male blind plug (Plastic) M12 母头塑料保护盖 Female blind plug (Plastic)	981010 996050	
	滑动电缆套管 Slip-on cable sleeves 4x18 mm	990000	电缆直径 4.0...6.5 mm Cable diameter 4.0...6.5 mm
	可拆卸电缆套管 Snap-on cable sleeves 4x18 mm	990001	电缆直径 4.2...7.0 mm Cable diameter 4.2...7.0 mm
	标识板 Label plates 4x18 mm	990002	
	M12 连接器预铸线安装扳手	600004002	
	M12 连接器现场接线安装扳手	600004003	

M12 圆形连接器

客户订制 Custom customization

- M12 Y 型直出 - 2M12 插孔直出



连接器技术参数 TECHNICAL DATA FOR PLUG CONNECTORS

M12 圆形连接器 直出线 Round plug connector straight / 90°

插针 Male 直出 Straight

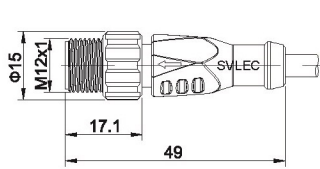

单端预铸线束 With open ended wires

插针 Male 90°

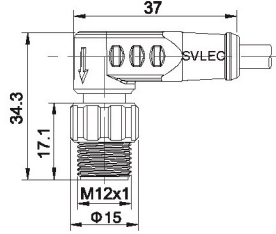

插孔 Female 直出 Straight

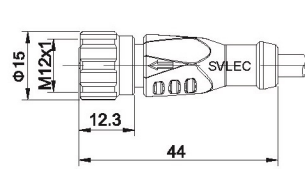

插孔 Female 90°

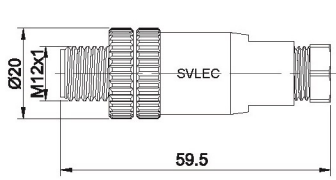
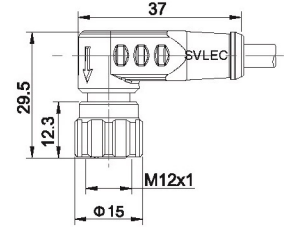

现场接线 / 螺钉压接 Field-wireable / screw terminals

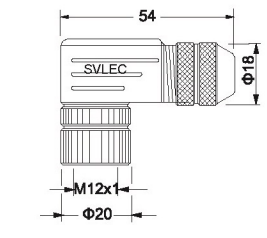
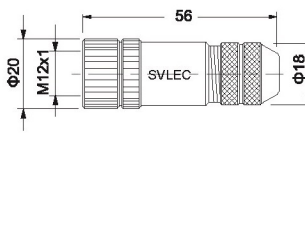
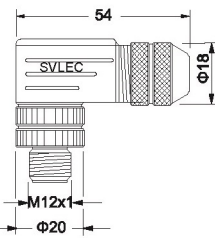
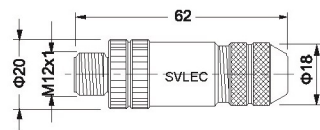
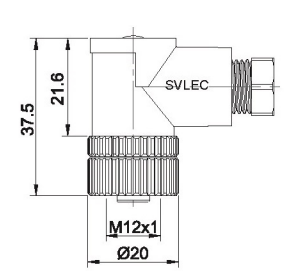
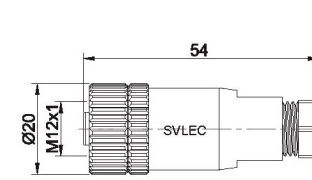
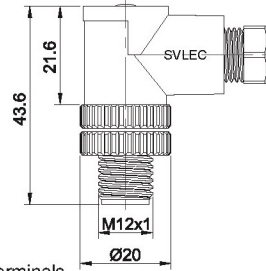

现场接线 / 螺钉压接 / 屏蔽 Field-wireable / screw terminals / shielded

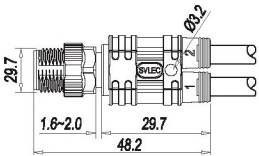

Y型线 Y-distributor

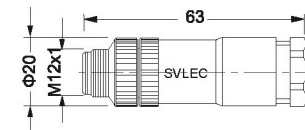

现场接线 / 可接 2 根电缆
Field-wireable / Can receive 2 cables can receive 2 cables