

---

Job Preparation

---

Job Assistance

---

Job Monitoring

# Software Solutions



Increased software intelligence

# Software solutions from Job Preparation to Job Monitoring.

DMG MORI software solutions offer enormous potential for the optimisation of your value-adding chain with the three product lines Job Preparation, Job Assistance and Job Monitoring.

The Job Preparation advanced product line supports you in the manufacturing preparation process – from training and development to programming and simulation. With intelligent software products from Job Assistance, you can save energy by reducing costs, get immediate online assistance during a production stoppage or utilise exclusive high-end production cycles. And, with comprehensive Job Monitoring, you can not only check the machine status anywhere at anytime, you can also plan and perform upcoming maintenance through software support.

Apart from our proprietary products, we also offer professional MDE and CNC editing solutions from our partners. The highlight is our integrated DMG MORI Process Chain software solution, which was created in close cooperation with SIEMENS for the production of new components.

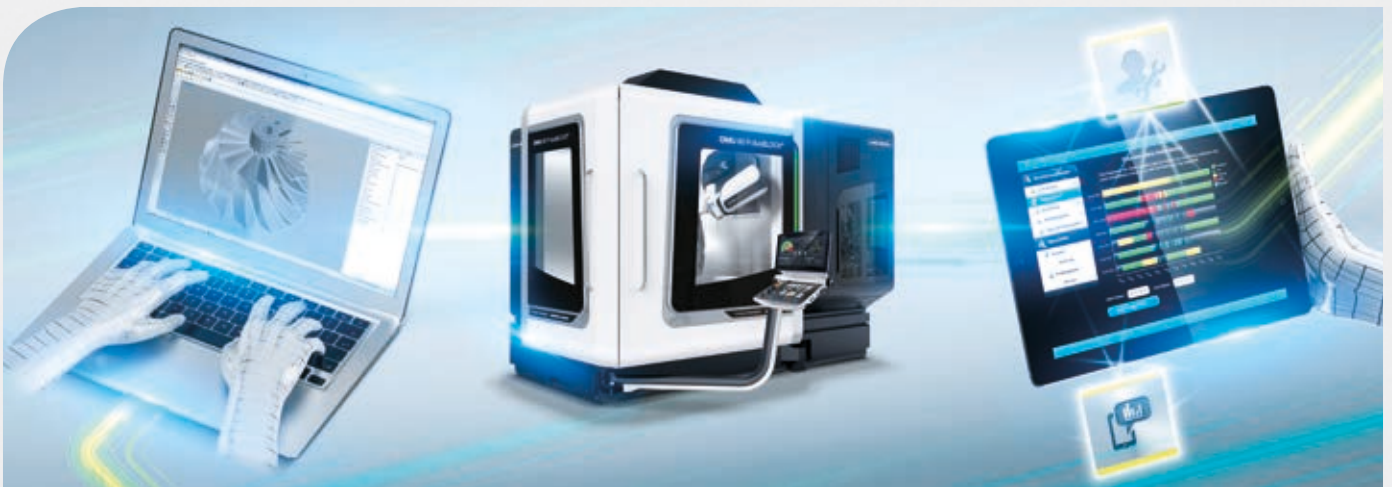

## Job Preparation

- + DMG MORI Process Chain
- + DMG MORI Virtual Machine
- + DMG MORI MfgSuite
- + DMG MORI Programmer 3D Turning
- + DMG MORI Programming / Training Software
- + DMG MORI-AP series

## Job Assistance

- + DMG MORI Netservice
- + DMG MORI MONITOR
- + DMG MORI Technology Cycles
- + MPC
- + DMG MORI Machine Check
- + DMG MORI Energy Saving
- + MCC-LPS III
- + MCC-TMS

## Job Monitoring

- + DMG MORI Messenger
- + DMG MORI Service Agent
- + sysCut COMARA®
- + DMG MORI SMARTkey®

Job Preparation

# DMG MORI Process Chain – from the idea to the finished work piece.

- + Highest process safety thanks to DMG MORI and SIEMENS
- + CAM system with the most modern technology for turning and milling
- + Certified post processor
- + Export of all production-relevant data from the NX CAM in DMG MORI Virtual Machine
- + Exact machine simulation through integration of the original PLC and NC
- + Maximum efficiency of your DMG MORI machine through faster setup

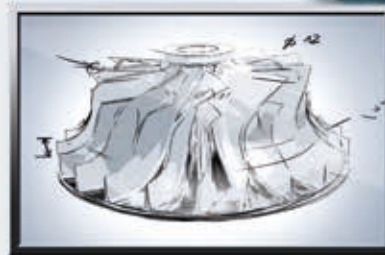
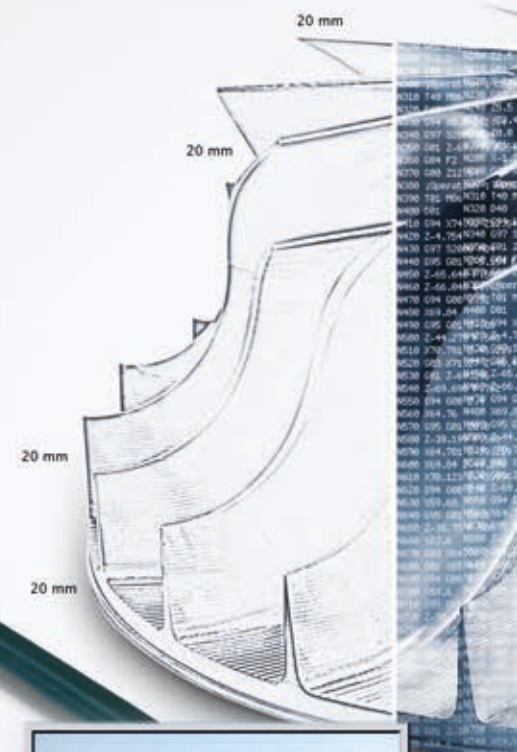

## Idea

### SIEMENS NX CAD

The new work piece is already sketched on paper and can now be modelled to full scale in the CAD environment. Thanks to the most modern CAD technology, you can quickly prepare a model. Even adjustments made later will be directly adopted in the NX CAM model.

## Programming

### SIEMENS NX CAM

NX CAM supports all machining strategies for your DMG MORI machine, including simulated milling, boring and turning functions up to 5-axis machining. The interpolation produces a tool path that achieves a superior surface quality.



## 1:1 Simulation with DMG MORI Virtual Machine

### 1:1 Simulation

#### DMG MORI Virtual Machine

After the export of the NC programme and all relevant 3D resources from NX in DMG MORI Virtual Machine, all functions of the NC and PLC can be subsequently tested and verified. Thanks to the 1:1 machine simulation, you can identify collisions and programme errors on the PC – not on the machine.

### Production

#### DMG MORI Machine Tools

No longer does anything stand in the way of realising your idea on a DMG MORI machine. As usual, you will finish your production projects using the latest machine and control technology on your DMG MORI machine. However, with SIEMENS and DMG MORI, machining is now more economical, safer and faster!

---

Job Preparation

# DMG MORI Process Chain – the individually scalable CAD / CAM and simulation solution.

## „DMG MORI Process Chain light“

“DMG MORI Process Chain light” consists of NX CAM from SIEMENS and a post processor, certified by DMG MORI as well as optional 3D work space simulation, based on NC code. This option is suitable for customers who use machines which cannot be mapped via DMG MORI Virtual Machine.

## MTSK

For customers who already use NX CAM, we offer so-called MTSKs (Machine Tool Support Kits). These MTSKs are tailored to DMG MORI machines and expand NX CAM with a post processor, the 3D machine model, an acceptance module and (optionally) the DMG MORI Virtual Machine.

### Facts

- + NX CAM from SIEMENS:  
Latest technologies for turning and milling
- + Certified post processor, tailored to  
DMG MORI machines
- + Simple export of production-relevant data  
from NX CAM

### Highlights

- + Individually scalable CAD / CAM and  
simulation solution
- + Highest process safety thanks to realistic  
simulation
- + Reduced changeover and set-up times  
for maximum utilisation
- + Minimal non-productive times thanks  
to optimised traverses
- + Easy generation of 3D models for  
workholding fixtures and tools
- + 3D objects need to be created only once
- + Simulation on NC code basis

## Customer story LINKE GmbH – maximum productivity and production safety.

LINKE GmbH from Magdeburg is renowned for series production of precision parts for hydraulic motors. The increasing complexity of parts in smaller batch sizes has increasingly hindered optimal process flow. In parallel with the investment in a new 5-axis machining centre DMC 100 U duoBLOCK®, LINKE decided to adopt the DMG MORI process chain – with impressive results. Starting with programming in NX CAM and on the basis of the realistic 1:1 simulation, including collision monitoring in the DMG MORI Virtual Machine, the production process has been optimised for maximum output and safety.

1+2: DMG MORI Process Chain – 1:1 simulation with DMG MORI Virtual Machine  
3: Guido and Stefan Linke, Management LINKE GmbH



Guido Linke has used the DMG MORI process chain since 2011. Besides CAM programming, it also comprises the DMG MORI Virtual Machine. The complete production is simulated on the DMC 100 U duoBLOCK® and checked for possible programming errors before actual production starts.

**LINKE GmbH**  
Mittagstrasse 19  
D-39124 Magdeburg  
Tel.: +49 391-280 333 0  
Fax: +49 391-280 333 23  
E-mail: [info@linke-md.de](mailto:info@linke-md.de)  
Internet: [www.linke-md.de](http://www.linke-md.de)

Job Preparation

## DMG MORI Virtual Machine – Efficiency, safety, speed.

DMG MORI Virtual Machine integrates geometry, kinematics and dynamics as well as all the functionalities of NC and PLC. The 3D machine models are not remodelled, but are based on the original CAD construction data of your DMG MORI machine. Thanks to shop floor-oriented programming in DMG MORI Virtual Machine, you can decide on your PC how best to achieve the technical aspects of customer orders and whether you have the correct resources available – and that includes accurate cycle time calculation.

Avoiding collisions and simulating all machine functions not only assures a high level of safety during planning and production, but also offers completely new perspectives in training and continuing education.





## Highlights

- + Efficient production start through optimal preparation
- + Highest process reliability through collision and work area monitoring
- + Faster setup and retooling
- + Complete availability of all cycles and NC functions
- + 3D data import via the embedded SolidWorks
- + Quickly create 3D data through a parametric individual parts database
- + Actual cycle times through PLC integration
- + Quickly learn new DMG MORI machines and controls

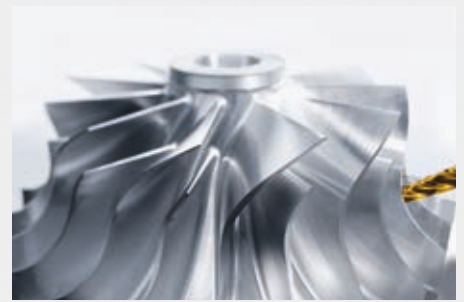
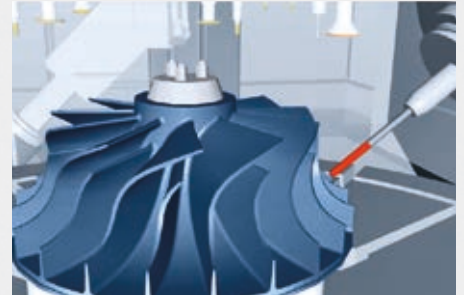

## Applications



### Work preparation – The highest productivity from the start

With DMG MORI Virtual Machine, you can prepare and test from the start and above all, plan the right workholding on your virtual machine table. Actual tool data and zero point are taken into as much consideration as the geometry of your part and the fixtures. This significantly reduces setup time and increases safety.



### Feasibility analysis – Safety to more efficiency

With DMG MORI Virtual Machine, you can plan and verify all of your machining operations and processes with absolute safety and confidence. The exact programme that will later be run on your DMG MORI machine will be simulated. Your work piece machining time is no longer unknown but now almost 100 % accurate.



### Training and continuing education – Learning with a machine tool

In DMG MORI Virtual Machine, all NC functions like machining cycles, G functions and parametric programmes, are at your disposal. This allows you to learn the complete capabilities of your machine in a user-friendly platform. Operation is simple via the virtual or real DMG MORI ControlPanel.



Job Preparation

# DMG MORI MfgSuite – simulation, programme testing, collision monitoring.

## DMG MORI MfgSuite Software

Create machine programmes easily with the MfgSuite from DMG MORI.

Highlights

- + Exact machine models are made available by DMG MORI and allow fully reliable machine configuration
- + Complete integration of the MAPPS parameters
- + Virtual machine environment as for the real machine
- + Full compatibility with MAPPS / DMG MORI-AP tool data

Availability

NMV series, NH series, NTX series, NT series, NVX series, NLX2500, NHX4000, NHX5000, NHX5500, NHX6300

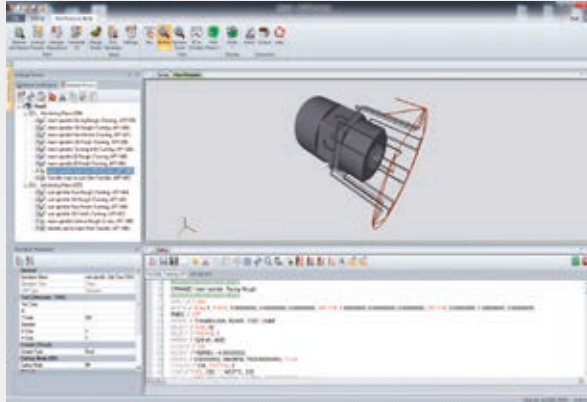

## MfgSuite Post Processor

### Highlights

- + Universal DMG MORI-APT\*-CL format, which can be transferred to different DMG MORI machines
- + Integration of the standard template for every DMG MORI machine, tested by DMG MORI
- + Adaptable post-template, which can be tailored to the specific NC programme version of the customer
- + Supports TCP-NC code generation for 3-axis, 3-axis + 2 indexing axes and fully interpolating 5-axis programmes
- + Seamless integration with NC simulation for NC programme testing and collision monitoring

### Availability

NMV series, NH(X) series, NV(X) series, NL(X) series, NT series

\*DMG MORI-APT is an expansion of the standard APT CLDATA (ANSI NCITS 37-1999 and ISO 4343:2000), which is recognised by DMG MORI post processors.

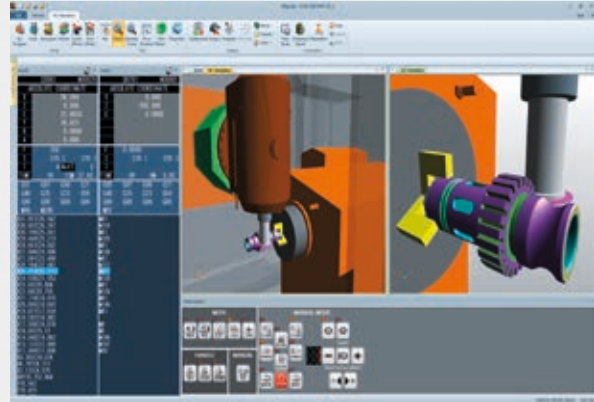

## MfgSuite NC Simulation

### Highlights

- + MfgSuite (Manufacturing Suite) is Windows application software which performs machining simulations with powerful and highly precise collision monitoring
- + Exact models of DMG MORI machine tools are supplied as standard for easy configuration\*
- + Hassle-free use of the MAPPS parameters

### Availability

NTX series, NHX series, NVX series, NLX series, NMV series, NT series, NH series

\*Machine models: internal cover, spindle and work table (customer-specific design requires separate consultation). A machine model with standard specifications is included with this software. Additional machine models are available at extra cost.

Job Preparation

# DMG MORI Programmer 3D Turning – Secure programming, secure production.

With DMG MORI Programmer 3D Turning you have a programming and simulation tool that allows you to programme quickly and efficiently while minimising programming error-related collisions and lost production on your DMG MORI machines.

Prepared templates support diverse production processes, resulting in much shorter programming times. The NC blocks can be created with Editor, cycles or CAM and offer optimal preparation for work pieces on your DMG MORI turning machines.

The realistic simulated work area reduces setup time considerably and puts you in a position to minimise production losses caused by programming errors and the resulting costs – simply, safely and cost effectively!

1: Significantly faster setup due to realistic simulation of the work area

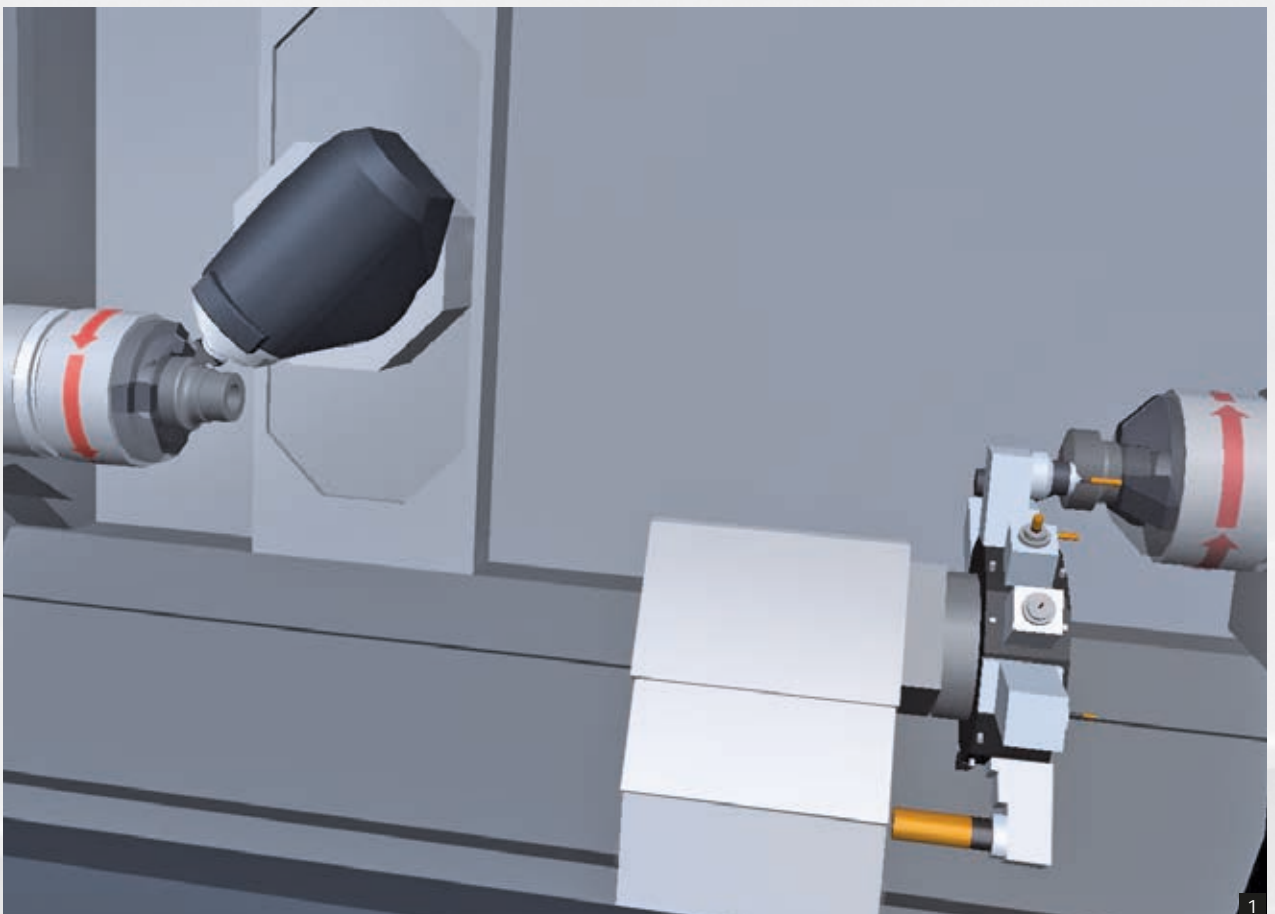

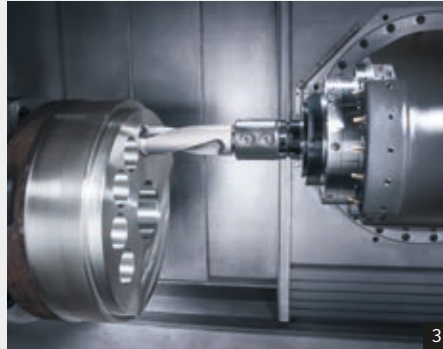
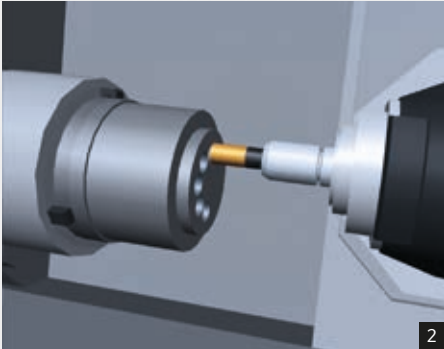

2: Drilling simulation with B-axis on the CTX gamma TC  
3: Drilling after the simulation

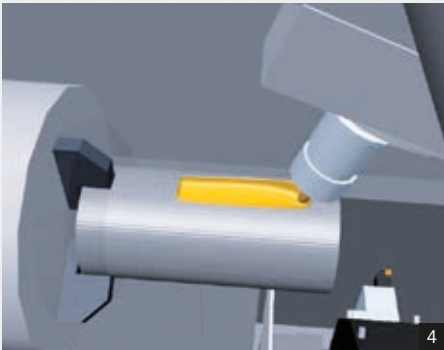

4: Simulated 5-axis machining  
5: 5-axis machining



## Highlights

- + 50 % faster setup
- + Inspection of the programme in advance via the 3D simulated work area
- + Optimally tailored complete package – ready to use
- + Connection to existing CAM systems is possible
- + Automatic generation of proven structured programming
- + Imported IGES-, STEP- and DXF-formats (Optional)
- + Avoid repair costs with collision monitoring
- + Part production time estimation at the push of a button
- + Used during work preparation
- + Import 3D tool models via TDM Systems (Optional)
- + Linking of the DMG MORI Virtual Machine (Optional)

## Features

- + Programme creation via the NC editor or the 2D CAM
- + Standard libraries for selecting tools and fixtures
- + Extensive selection of programme templates
- + Tailored 3D work area simulation
- + Automatically generated tooling sheets with tools and machining information
- + Importing externally created NC blocks (3D 5-axis milling machining)

- DMG MORI Programming / Training Software
- DMG MORI-AP series

## Job Preparation

# DMG MORI Programming / Training Software – Advancement through know-how.

Open your students' eyes to new perspectives the new production possibilities. With DMG MORI Programming / Training Software, we offer educational institutions and industrial companies in the areas of CNC turning, milling and new technologies, the most efficient solution with practice-oriented training for even more productivity.

Practice-oriented training is a significant factor in improving productivity. With the use of control-identical software on separate programming stations, you are supporting your students and trainees in learning industry-specific process-optimising programming skills. We also offer many other products to help you create a modern learning and training environment.

In the industrial sector, DMG MORI Programming / Training Software supports you significantly in your efforts to improve productivity. Through the use of control-identical software, you can programme and simulate independently from your DMG MORI machine. This allows you to increase your machine availability and reduce your error rate during production.

1: Industry-oriented programming training 2: Programming independently from the machine 3: Control-identical keyboards



## Highlights

- + 1:1 programming with control identical software
- + Location-independent training and programming
- + Practice-oriented learning
- + Export created Programmes to your DMG MORI machines
- + Increase employee knowledge
- + Reduced errors through test runs on the PC
- + Higher availability through PC programming and simulation
- + Faster integration of new machines

# DMG MORI-AP series – automatic programming systems.

Programming systems from DMG MORI are application systems, which allow you to easily create machine programmes on your PC. Thanks to easy operation – you merely need to follow the on-screen instructions and enter data about the shape of a product – times for the creation of programmes can be reduced drastically. The functions, details and operability are completely compatible with the dialogue programming systems of the MAPPS operating systems.

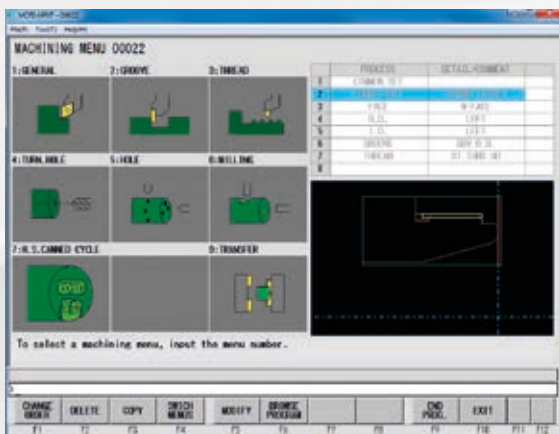

## Highlights

- + Automatic dialogue programming
- + Functions for multi-axis machining
- + Input of fast, fixed cycles
- + Graphical simulation testing

## Availability

- + All MAPPS control systems

**Information:** We distinguish between, **DMG MORI-APM** – Automatic Programming systems for machining centres, **DMG MORI-APL** – Automatic Programming systems for turning machines, **DMG MORI-APNT** – Automatic Programming systems for integrated milling / turning centres (NT series) and **DMG MORI-APNZ / ZT** – Automatic Programming systems for NZX series.

Job Assistance

# DMG MORI Netservice – Green light for your machine.

For over 10 years, DMG MORI Netservice has offered you immediate access to the service expertise of DMG MORI.

Should you need the support of DMG MORI with technical problems, you can quickly contact DMG MORI Service via a secure internet connection at the push of a button on your machine control. The DMG MORI service technician best qualified to address your issue can immediately conduct a detailed problem analysis and even fix many machine problems remotely.

This service comes as standard for all machines produced since April 2010. However, if you would like to utilise this DMG MORI service for an older machine – we will gladly upgrade your existing machine with DMG MORI Netservice!

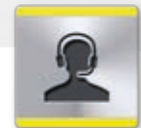

## Highlights

- + Comprehensive analysis and technical support for your DMG MORI machine
- + Faster, bidirectional data transfer
- + On-line access to control system and additional telephone service
- + Remote, direct access to the control system
- + No language barriers, because the language of the control system can be changed remotely
- + After a call to the Hotline and authorisation by the customer, the service engineer gets direct access to the control system
- + VPN connection with the highest data security
- + Significant increase in machine availability
- + Reduced service, personnel and travel costs



Job Assistance

## DMG MORI MONITOR – remote screen access and observation system.

With the extension software DMG MORI MONITOR, the DMG MORI service technicians can access your machine, which results in immediate fault analysis / remedy or the booking of an optimally planned service visit, leading to the best possible security of your production.

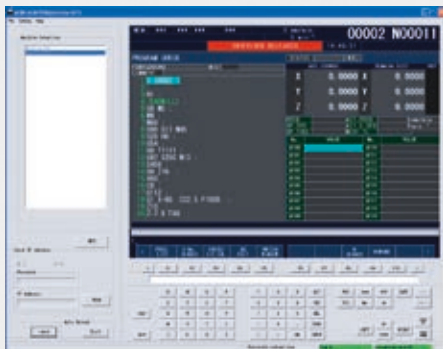

### Highlights

- + Transfer of your error messages to the DMG MORI service centre
- + Immediate fault analysis / remedy by DMG MORI service technicians
- + If necessary, an optimally planned service visit is arranged



Job Assistance

# Exclusive DMG MORI Technology Cycles – turning and milling.

DMG MORI technology cycles comprise decades of experience from DMG MORI application development. Even complex machining processes can be entered conversationally directly at the machine control via simple, parametrised input screens. Special DIN programming is not required since the processing functions are generated automatically. Save up to 60 % machining time!



## Operating comfort

- + Improved operating comfort
- + Support of the operator
- + Higher availability



## Time reduction

- + Increased efficiency
- + Reduction of machining times



## Technology integration

- + Technology integration of third party machining cycles on a turning or milling machine



## Component precision

- + Increased part precision, surface quality and dimensional accuracy



## Process safety

- + Increased process safety as well as protection of the machine, parts and tools
- + Risk minimisation in producing a work piece





## Highlights – turning

- + 5-axis simultaneous machining
- + Gear hobbing: Splines, worm gears, individual gear tooth milling
- + Off-centre machining: e. g. for eccentric features, crankpins
- + Tool monitoring system
- + Alternating speed: for vibration-critical machining
- + Multi-thread cycle: for the production of threads with free contours
- + Turret centre: for using a rotating centre on the turret
- + Turret head steady rest: for full machining of shafts
- + Programme condition control system: for multi-channel machines

## Availability

- + Dependent on product, machine type and control system



## Highlights – milling

- + ATC – Application Tuning Cycle: Process-oriented feed drive tuning at the touch of a button
- + MPC – Machine Protection Control
- + 3D quickSET®
- + Interpolation turning
- + Includes B-axis
- + Grinding package: integration of grinding technology
- + Alternating speeds
- + Use of multiple-edge turning tools

## Availability

- + Dependent on product, machine type and control system

Job Assistance

# MPC – Machine protection through quick shutdown and process control.

The new Machine Protection Control (MPC) guarantees optimal control of your machine during the milling process with the four basic functions: monitoring, process control, machine protection and data logging.

The system offers protection under critical vibration conditions by means of quick shutdown as well as process monitoring with defined process response.



## Highlights

- + Quick shutdown in case of critical vibration conditions
- + Increase of spindle service life
- + Diagnosis and optimisation of the machining process
- + Protection of the machine and tools
- + Ability to plan maintenance and repair
- + Detection of causes in case of spindle failures
- + Optimal utilisation of tool service life
- + Increase of machine availability



1: Collision display with current level values  
2: Graphic display of the current level value

# DMG MORI Machine Check – early warning system for maintenance.

Day-to-day business in machining operations is dominated by deadlines. Planned maintenance intervals can easily be overlooked as a result of the hectic pace. Signs of imminent damage are not recognised.

Even small lapses can over time lead to major problems, which then cost unnecessary money and time, and in the worst case lead to customers not being supplied on time.

Therefore DMG MORI Machine Check is the right tool for everyone who wants to save cost and time and prevent unnecessary annoyance, by means of preventative maintenance.



## Highlights

- + Concise information and reminders of necessary maintenance procedures
- + Defined maintenance intervals
- + Acknowledgement via Service-SMARTkey or Inspection-SMARTkey
- + Reminder of machine maintenance for better planning of production
- + Increased service life
- + Timely service scheduling

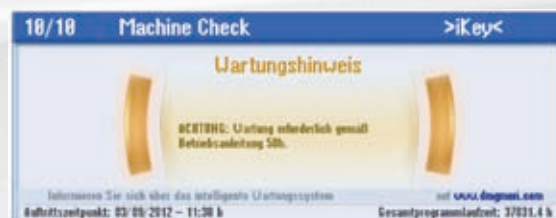

Job Assistance

# DMG MORI Energy Saving – save up to 30 % energy and increase productivity.

As a co-founder of the Blue Competence Initiative, sustainable manufacturing technology and resource-saving machine tool design have already become the standard at DMG MORI. Thanks to intelligent technology, the energy consumption of our machines has fallen on average by 20 % over the entire life cycle.

■ **Control system**

DMG MORI GREENmode: Increased process speed and energy saving thanks to the intelligent control of feed

■ **Intelligent electronics and drive technology**

Use of controlled motors in accumulator technology

■ **Drives capable of energy recovery**

Use of regenerative braking energy for acceleration

■ **Optimised mechanics**

Increased dynamics thanks to a reduction in moving masses and weight balancing

■ **Minimised friction**

Thanks to the use of roller guides and linear motors

■ **Control system**

DMG MORI AUTOshutdown: Intelligent standby control system to avoid unnecessary energy consumption when idle

■ **Simulation with the DMG MORI Virtual Machine**

Shortest set-up times thanks to prior simulation, reduced non-productive times thanks to optimisation of the fixture and machining / tool sequence

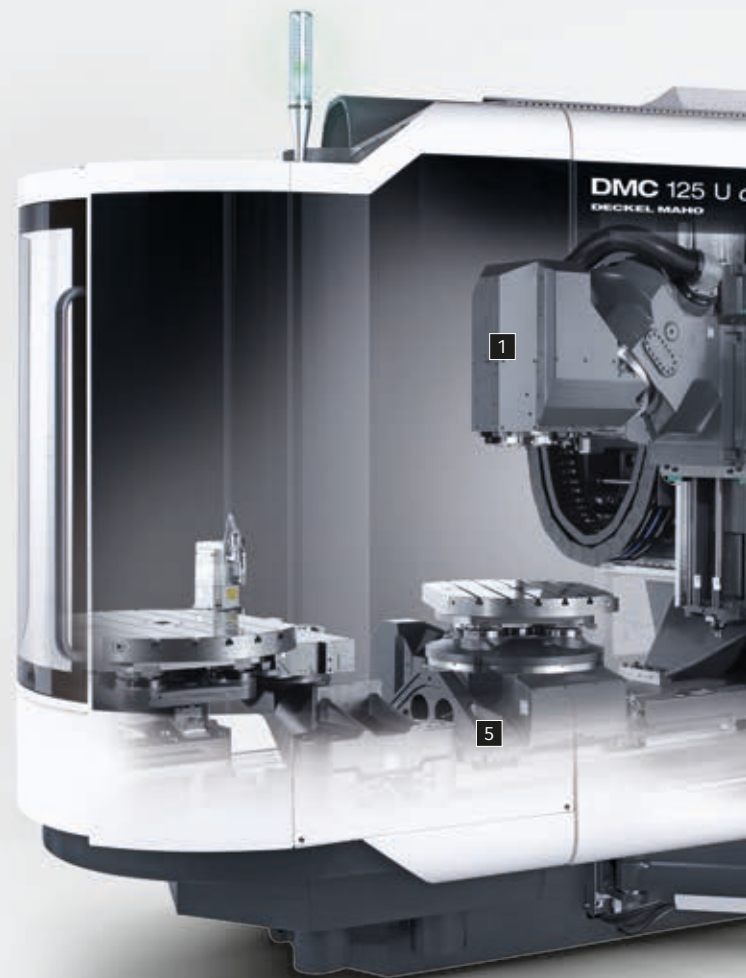

## Highlights

- + Software and hardware measures
- + DMG MORI *AUTOshutdown*: Automatic standby function
- + DMG MORI *GREENmode*: Adaptation of machine parameters for efficient operation
- + Significant saving of energy costs
- + Maximum efficiency

## Saving potentials

		DMC 125 H	CTX beta 800
<b>Measured values</b>			
Standby	kW	2	0.7
Ready for operation	kW	5.5	2.6
Production	kW	7.6	7.2
<b>Energy</b>			
without DMG MORI methods	MWh	56	41
with DMG MORI methods	MWh	35	28
<b>Saving potential per year</b>		<b>37 %</b> <b>4,100 €</b>	<b>32 %</b> <b>2,700 €</b>

**Basic conditions:** Use of DMG MORI Energy Saving and DMG MORI *AUTOshutdown*; machining of test work pieces according to proposed Japanese standards over 51 weeks, 5 days/week, 2 shifts, without manual shutdown over the weekend; energy price 20 cent/kWh



## Energy efficiency – technology that quickly pays for itself

With our machines you can save up to **30 % of your energy requirements** and produce more efficiently at the same time. Ex factory and without extra cost.

Thanks to intelligent software and resource-friendly design, our machines achieve significant energy cost savings, even today, across the entire life cycle.

In addition **DMG MORI GREENmode** and **DMG MORI AUTOshutdown** come as standard in our machine tools, whereby energy costs can additionally be reduced by up to € 4,100.00 per year (calculated for a typical production operation of 52 weeks production/year, 5 days production / week, 2 shifts/day and 1 hour for start-up per day).

## Job Assistance

# MCC-LPS III – software for the control of pallet change systems.

MCC-LPS III the cell control system of the next generation, to maximise the productivity of the LPP (Linear Pallet Pool) and other pallet change systems from DMG MORI. It offers flexible interfaces for order management, system monitoring and a multitude of production reporting functions. It is the first and only cell control system with integrated intelligent capabilities for planning and the creation of time plans.

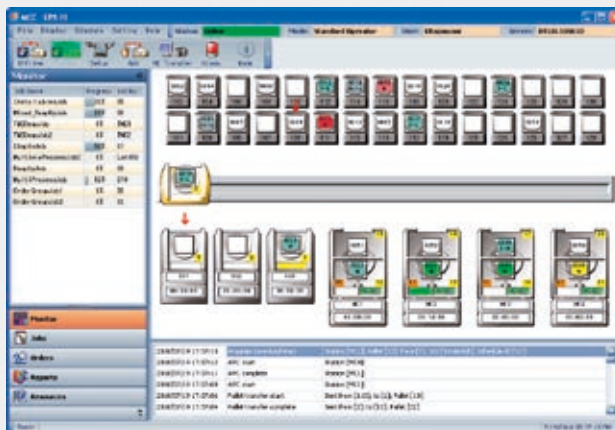

Job Name	Part Date	IN-PROCESS	REWORK	IN-PROCESS	REWORK	IN-PROCESS	REWORK	IN-PROCESS	REWORK	IN-PROCESS	REWORK	IN-PROCESS	REWORK
VariableAssembly	8/1/2018	3	0	0	0	0	0	0	0	0	0	0	0
VariableBase	8/1/2018	3	0	0	0	0	0	0	0	0	0	0	0
VariableBase	8/1/2018	3	0	0	0	0	0	0	0	0	0	0	0
VariableBase	8/1/2018	3	0	0	0	0	0	0	0	0	0	0	0
Stamp & Seal	8/1/2018	21	0	0	0	0	0	0	0	0	0	0	0
PROCESS_1	8/1/2018	4	0	0	0	0	0	0	0	0	0	0	0
PROCESS_2	8/1/2018	2	0	0	0	0	0	0	0	0	0	0	0
PROCESS_3	8/1/2018	2	0	0	0	0	0	0	0	0	0	0	0
PROCESS_4	8/1/2018	2	0	0	0	0	0	0	0	0	0	0	0
PROCESS_5	8/1/2018	4	0	0	0	0	0	0	0	0	0	0	0
PROCESS_6	8/1/2018	3	0	0	0	0	0	0	0	0	0	0	0

## Highlights

- + The highly reliable system from DMG MORI allows easy handling and management of pallet transfer
- + Machine programmes can be edited and downloaded automatically
- + Priorities for urgent production demands can be applied flexibly
- + Linking with the “MCC-TMS Tool Management System” – application system
- + Available for all MAPPS control systems



# MCC-TMS – the tool management system.

MCC-TMS is a tool management system, which allows central management of tools and components, and significantly reduces errors and set-up times. The system is not only compatible with Tool ID, but can also be used in conjunction with MCC-LPS III for centralised management of all LPP tools, to support long-term, interruption-free operation of machines. In addition, information regarding problems like tool wear is also available in combination with the MAPPS tool management system.

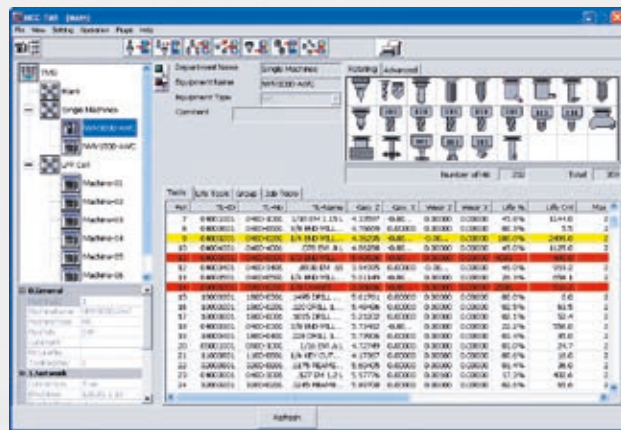
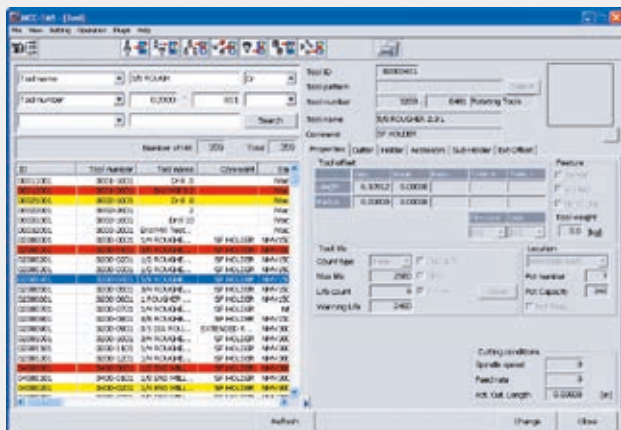

## Highlights

- + Improved system handling thanks to an intelligent centralised tool management system
- + Compatible with ID chips
- + Compatible with a tool presetter interface
- + Standardisation (exchange of know-how, machining database)
- + Max. 7-digit group number

Job Monitoring

# DMG MORI Messenger – inform and evaluate on smart phones, tablets and PCs.

## Reduced idle times – increased productivity

The new DMG MORI Messenger allows you to access detailed machine condition information live – at any time and independent of the location. Thanks to permanent on-line monitoring you can always keep an eye on your production and thereby reduce down-times significantly.



## Highlights

- + Permanent on-line monitoring of your DMG MORI machines
- + Web applications for all smart phones and browsers
- + Live machine status display
- + Detailed status information
- + Increased output thanks to reduced idle time
- + Range of analyses and reports

## Data evaluation and utilisation potential

The DMG MORI Messenger provides a range of data evaluation options to give you a structured overview of your production and machines.

### Your advantages

- + Clear machine live status
- + Status history charts and analyses
- + Work piece counter history charts and analyses
- + Override chart and alarm history
- + Programme runtime calculation
- + Simple generation of PDF reports, allowing you to save and print the charts



## Exact knowledge for economic success

Don't let any valuable time go to waste. Using information from the DMG MORI Messenger, you can quickly react to deviations from target production. Whether you're monitoring one or several machines online, the status information is displayed clearly on your smartphone and within your browser.

### You receive the following information

- + Machine status display as an image of the signal lamp or Lightline
- + Status history as a time line of the control status
- + Target and actual quantity (for SIEMENS)
- + Previous and current work piece runtime (for SIEMENS)
- + Selected programme
- + Override (warning icon and value)
- + Current warnings and error messages
- + Message function from the machine to the DMG MORI Messenger for operator feedback (only for SIEMENS and iTNC 530)



Job Monitoring

# DMG MORI Service Agent – Warning in advance, service on time.

The DMG MORI Service Agent is an intelligent maintenance system for increased availability of your DMG MORI machines.

Through DMG MORI Service Agent, you will be informed of required regular maintenance work and supported in carrying it out. The actual machine operating time is automatically read by the PLC and logged. Based on this data, you will be able to plan maintenance work and will be supported by computer-generated documentation that will help you carry out necessary maintenance work yourself. An integrated assistant will help you quickly and easily order replacements for your worn parts via the DMG MORI 24/7 Service Hotline, Fax or E-Mail – You save time and increase your productivity!

## Highlights

- + Automatic triggering of upcoming maintenance and service activities
- + Advance notice of maintenance work for worn parts
- + Support of maintenance and service work through detailed activity lists and detailed instructions
- + Easy generation of order templates for wear parts
- + Coordination of maintenance activities for up to 32 machines by installation on just one external PC

## Supported control systems



- + SIEMENS 840D powerline
- + SIEMENS 840Dsl Advanced
- + SIEMENS 840Dsl Operate
- + HEIDENHAIN iTNC 530
- + HEIDENHAIN MillPlus iT V410T–V600
- + HEIDENHAIN TNC 620/640
- + FANUC series 16i / 160i, 18i / 180i, 21i / 210i
- + HEIDENHAIN CNC-Pilot 620 / 640\*

\*from NC: V688945 V03 possible



Job Monitoring

# sysCut COMARA® – The key to more transparency.

Keep up to date with the production status and work history of your machines. Receive detailed information on what was produced when, where and how, as well as in what timeframe it was finished and what is currently being produced. Evaluations and reports draw your attention to key indicators of past, current and future business performance.

The MDE sysCut tool offers you the potential for a more transparent machining process – because transparency creates productivity. By gathering information directly from the CNC control, sysCut offers you an unprecedented wealth of information.

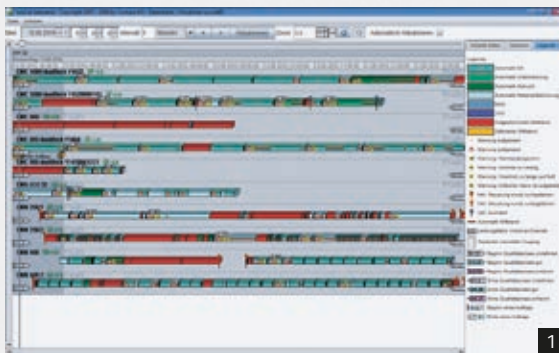

1

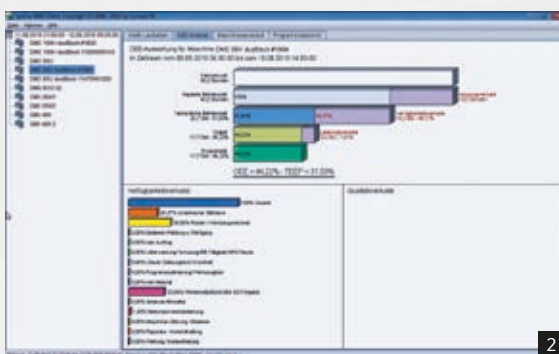

2

1: Process history for your all of your machines  
2: OEE analysis of your DMG MORI machine

## Highlights

- + Generating KPIs (Key Performance Indicators) based on process data:
  - OEE (Overall Equipment Effectiveness)
  - Six Sigma
  - BSC (Balanced Scorecard)
- + Identification of unproductive waiting periods in the NC Programme
- + Error log book
- + Clear identification and diagnosis of downtime and interruptions
- + Target and actual results comparisons
- + Efficiency and feasibility analysis
- + Documentation of safety-critical parts (Aerospace and Automobile Industries, Medical Technology)

# DMG MORI SMARTkey® – customised access and settings.

Since its market introduction, DMG MORI SMARTkey® has established itself as a “small” status symbol. No need to go to the machine with a key. And the DMG MORI SMARTkey® does not only look good. It offers far more options than just the selection of the type of operation.

Customised authorisation of the operator together with relevant access rights or individualised preparation of the control system are just two examples. With its appeal and functionality the DMG MORI SMARTkey® underlines the perfect overall picture and the “emotional intelligence” of DMG MORI ERGOline® Control.



## Highlights

- + User-dependent releases
- + Customer-specific settings with the SMARTkey® manager
- + Backup and exchange of data via USB stick
- + Independent maintenance with the aid of the INSPECTIONkey
- + Better security control
- + Improved user-friendliness
- + Higher efficiency thanks to time savings, as manual log-in is bypassed
- + With internal USB memory\*

\*Only for CELOS® control system

3: DMG MORI ERGOline® Control with DMG MORI SMARTkey®  
4: CELOS® with 21,5"-ERGOline® with new DMG MORI SMARTkey®

## Headquarters

**Germany:****DMG MORI Deutschland**

Riedwiesenstraße 19  
D-71229 Leonberg  
Tel.: +49 (0) 71 52 / 90 90-0  
Fax: +49 (0) 71 52 / 90 90-20 00  
Service Hotline: +49 (0) 180 5 49 00 22

**Europe:****DMG MORI Europe**

Sulzer-Allee 70  
CH-8404 Winterthur  
Tel.: +41 (0) 58 / 611 5000  
Fax: +41 (0) 58 / 611 5001  
Service Hotline: +41 (0) 446 545 670

**Asia:****DMG MORI Japan**

2-3-23 Shiomi Koto-ku, Tokyo  
JP-135-0052, Japan  
Tel.: +81 3-6758-5900  
Fax: +81 3-6758-5919

**America:****DMG MORI USA**

2400 Huntington Blvd.  
Hoffman Estates, IL 60192  
Tel.: +1 (847) 593-5400  
Fax: +1 (847) 593-5433

## Europe

**DMG MORI Austria**

Oberes Ried 11  
A-6833 Klaus  
Tel.: +43 (0) 55 23 / 69 141-0  
Fax: +43 (0) 55 23 / 69 141-100  
Service Hotline: +43 (0) 17 95 / 76 109

**\_ Stockerau**

Josef-Jessernigg-Straße 16  
A-2000 Stockerau  
Tel.: +43 (0) 55 23 / 69 141-0  
Fax: +43 (0) 55 23 / 69 141-100

**DMG MORI Benelux****\_ Netherlands**

Wagenijselaan 48  
NL-3903 LA Veenendaal  
Tel.: +31 (0) 318-55 76-11  
Fax: +31 (0) 318-52 44-29  
Service Hotline: +31 (0) 202 00 81 83

**\_ Belgium**

Hermesstraat 4B  
B-1930 Zaventem  
Tel.: +32 (0) 2 / 7 12 10-90  
Fax: +32 (0) 2 / 7 12 10-99  
Service Hotline: +32 (0) 2 / 2 200 62-52

**DMG MORI Czech**

Kaštanová 8 · CZ-620 00 Brno  
Tel.: +420 545 426 311  
Fax: +420 545 426 310  
Service Hotline: +420 239 000 561

**\_ Planá**

Chýnovská 535  
CZ-39111 Planá nad Lužnicí  
Tel.: +420 381 406 914  
Fax: +420 381 406 915

**\_ Slovakia**

Brniánska 2  
SK-91105 Trenčín  
Tel.: +421 326 494 824

**DMG MORI France**

Parc du Moulin · 1 Rue du Noyer  
B.P. 19326 Roissy-en-France  
F-95705 Roissy CDG Cedex  
Tel.: +33 (0) 1 / 39 94 68 00  
Fax: +33 (0) 1 / 39 94 68 58  
Service Hotline: +33 (0) 8 10 90 20 20

**\_ Lyon**

Parc des Lumières  
1205 Rue Nicéphore Niepce  
F-69800 Saint-Priest  
Tel.: +33 (0) 4 / 78 90 95 95  
Fax: +33 (0) 4 / 78 90 60 00

**\_ Toulouse**

Futuropolis Bat. 2 · 2 Rue Maryse Hilsz  
F-31500 Toulouse  
Tel.: +33 (0) 5 / 34 25 29 95  
Fax: +33 (0) 5 / 61 20 89 19

**\_ Haute-Savoie**

Espace Scionzier · 520 avenue des Lacs  
F-74950 Scionzier  
Tel.: +33 (0) 4 / 50 96 41 62  
Fax: +33 (0) 4 / 50 96 41 30

**DMG MORI Hungary**

Vegyész u. 17-25 · B. Building  
H-1116 Budapest  
Tel.: +36 1 430 16 14  
Fax: +36 1 430 16 15  
Service Hotline: +36 1 777 90 57

**DMG MORI Ibérica**

Pol. Ind. Els Pinetons  
Avda. Torre Mateu 2-8 · Nave 1  
E-08291 Ripollet · Barcelona  
Tel.: +34 93 586 30 86  
Fax: +34 93 586 30 91  
Service Hotline: +34 91-2 75 43 22

**\_ Madrid**

C / Alcañiz 23 · E-28042 Madrid  
Tel.: +34 91 66 99 865  
Fax: +34 91 66 93 834

**\_ San Sebastián**

Edificio Igaraburu  
Pokopandegi 11, Oficina 014  
E-20018 San Sebastián  
Tel.: +34 943 100 233  
Fax: +34 943 226 929  
Service Hotline: +34 91-2 75 43 22

**DMG MORI Italia**

Via G. Donizetti 138  
I-24030 Brembate di Sopra (BG)  
Tel.: +39 035 62 28 201  
Fax: +39 035 62 28 210  
Service Hotline: 199 177 811

**\_ Milano**

Via Riccardo Lombardi 10  
I-20153 Milano (MI)  
Tel.: +39 02 48 94 921  
Fax: +39 02 48 91 44 48

**\_ Padova**

Via E. Fermi 7 · I-35030 Veggiano (PD)  
Tel.: +39 049 900 66 11  
Fax: +39 049 900 66 99

**DMG MORI Middle East**

Jebel Ali Free Zone · JAFZA Towers  
Lob 18, Office 2403, P.O. Box 262 607  
Dubai, U.A.E.  
Tel.: +971-4-88 65 740  
Fax: +971-4-88 65 741

**DMG MORI Polska**

ul. Fabryczna 7 · PL-63-300 Pleszew  
Tel.: +48 (0) 62 / 7428 000  
Fax: +48 (0) 62 / 7428 114  
Service Hotline: +48 (0) 62 / 7428 285

**DMG MORI Romania**

DN 65B, KM. 4+471  
RO-110180 Pitesti  
Tel.: +40 248 610 408  
Fax: +40 248 610 409

**DMG MORI Russia**

ul. Novohohlovskaya 23/1  
RU-109 052 Moscow  
Tel.: +7 495 225 49 60  
Fax: +7 495 225 49 61  
Service Hotline: +7 495 912 50 09

**\_ Jekaterinburg**

ul. Sofi Kowalewskoj 4, litera Z  
RUS-620049 Jekaterinburg  
Tel.: +7 343 379 04 73  
Fax: +7 343 379 04 74

**\_ St. Petersburg**

pr. Obuhovskoy Oborony 271, litera A  
RUS-192012 St. Petersburg  
Tel.: +7 812 313 80 71  
Fax: +7 812 313 80 71

**DMG MORI Scandinavia****\_ DMG MORI Finland & Baltics**

Jasperintie 310  
FI-33960 Pirkkala  
Tel.: +358 10 271 4450  
Service Hotline: +358 10 271 4460

**\_ DMG MORI Sweden**

E A Rosengrens gata 5  
SE-421 31 Västra Frölunda  
Tel.: +46 (0) 771 364 6674  
Fax: +46 (0) 31 476 351  
Service Hotline: +46 (0) 771 365 724

**\_ DMG MORI Denmark**

Robert Jacobsens Vej 6, 2.tv  
DK-2300 København S  
Tel.: +45 70 21 11 11  
Fax: +45 49 17 77 00  
Service Hotline: +45 70 21 11 12

**\_ Norway**

Bergsli Metallmaskiner AS  
Bedriftsveien 64  
NO-3735 Skien  
Tel.: +47 35 50 35 00  
Fax: +47 35 50 35 70

**DMG MORI Schweiz**

Sulzer-Allee 70  
CH-8404 Winterthur  
Tel.: +41 (0) 58 / 611 5000  
Fax: +41 (0) 58 / 611 5001  
Service Direct Line: +41 (0) 58 / 611 5555  
Service Hotline: +41 (0) 446 545 670

**DMG MORI South East Europe**

Ag. Georgiou 5 · Patriarchiko  
Pylaias, Cosmos Offices, PO 60233  
GR-57001 Thessaloniki  
Tel.: +30 2310 474486  
Fax: +30 2310 474487

**DMG MORI Turkey**

Ferhatpaşa Mah. Gazipaşa Cad. No: 11  
TR-34885 Ataşehir · İstanbul  
Tel.: +90 216 471 66 36  
Fax: +90 216 471 80 30  
Service Hotline: +90 216 47 16 636

**DMG MORI UK**

4030 Siskin Parkway East  
Middlemarch Business Park  
Coventry CV3 4PE · GB  
Tel.: +44 (0) 2476 516 120  
Fax: +44 (0) 2476 516 136  
Service Direct Line: +44 (0) 2476 516 130  
Service Hotline: +44 (0) 20 30241514

**DMG MORI Africa****Representative**

WIN-TECH Machinery & Tooling  
90 El Thawra Street  
El Golf Area Heliopolise  
11341 Cairo, Egypt  
Tel.: +202 2 690 36 08  
Fax: +202 2 690 36 09

**DMG MORI Europe AG**

Sulzer-Allee 70, CH-8404 Winterthur  
Tel.: +41 (0) 58 / 611 5000, Fax: +41 (0) 58 / 611 5001  
info@dmgmori.com, www.dmgmori.com